

RADIO RETAILING

McGraw-Hill Publishing Company, Inc.

25 CENTS PER COPY

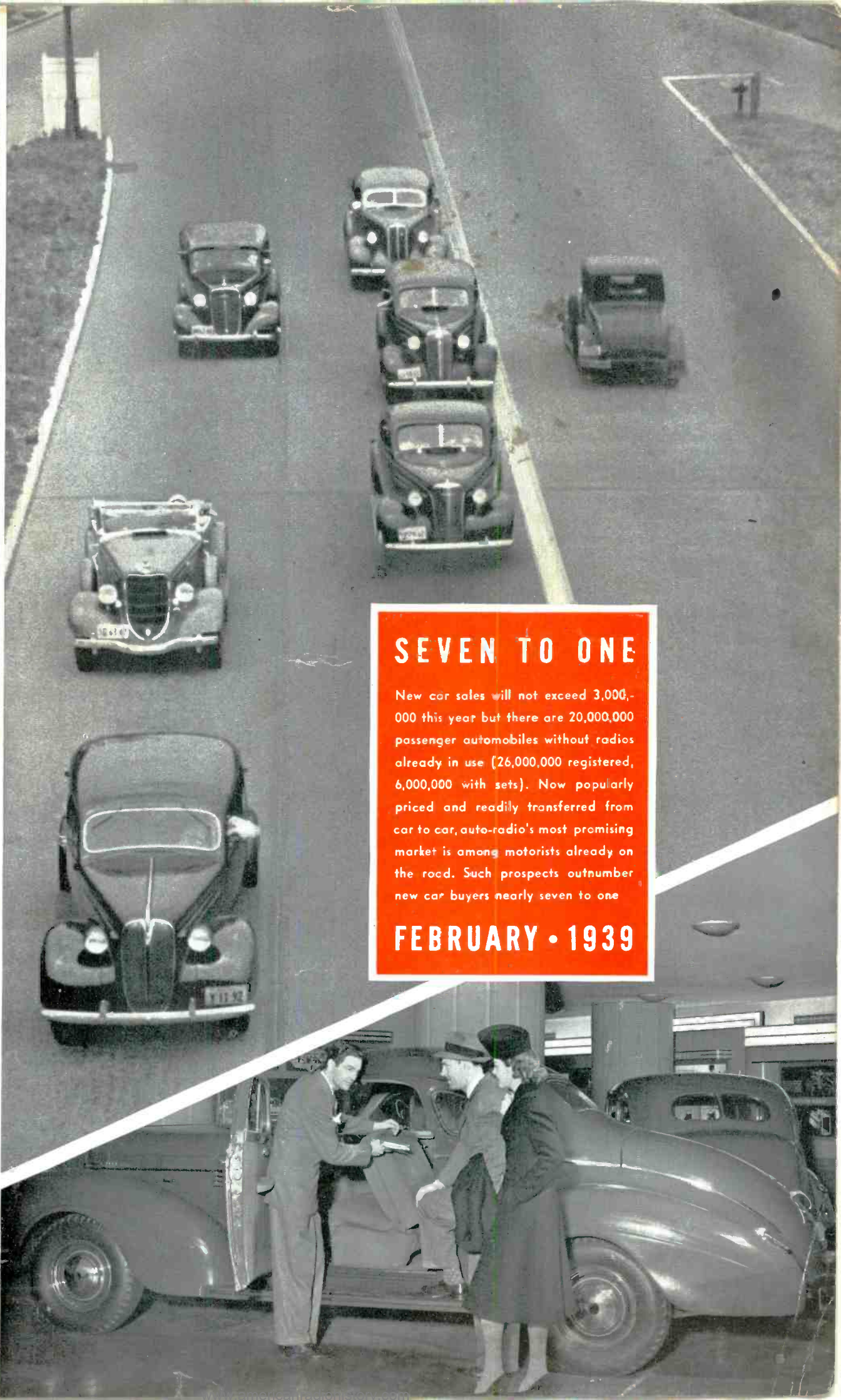

SEVEN TO ONE

New car sales will not exceed 3,000,000 this year but there are 20,000,000 passenger automobiles without radios already in use (26,000,000 registered, 6,000,000 with sets). Now popularly priced and readily transferred from car to car, auto-radio's most promising market is among motorists already on the road. Such prospects outnumber new car buyers nearly seven to one

FEBRUARY • 1939

Is It Any Wonder That

P. R. MALLORY & CO. Inc.

MALLORY VIBRATORS

REPLACEMENT

Lead the Field?

They are Original Equipment in Auto Radio Receivers built for:

BUICK ... CHEVROLET ... FORD ... HUDSON ... NASH ... OLDSMOBILE
 PONTIAC ... SEARS-ROEBUCK ... WESTERN AUTO ... FIRESTONE

and in Receivers made by:

Canadian Marconi
 Colonial
 Crosley
 Detrola
 Delco (Kokomo)
 Fairbanks-Morse
 Galvin (Motorola)
 Gilfillan
 Mission Bell
 Noblitt Sparks (Arvin)
 Northern Electric
 (Canada)
 Packard Bell
 Pilot

RCA
 RCA-Victor, Ltd. (Canada)
 Radio Products
 Rogers-Majestic, Ltd.
 Sparton (Canada)
 Stewart-Warner
 Stewart-Warner-
 Alemite (Canada)
 Stromberg-Carlson
 (U.S. and Canada)
 Zenith
 Western Electric

- ★ Millions in use
- ★ Trouble-free Long Life
- ★ Lowest Cost per Hour

Insist on Mallory
Buy the best
They cost no more!

Only the Second Edition Mallory-Yaxley Radio Encyclopedia gives you all data on every Vibrator application. It covers every servicing problem — you cannot afford to be without it. Ask your distributor.



Use
P. R. MALLORY & CO. Inc.
MALLORY
 REPLACEMENT
 CONDENSERS...VIBRATORS

P. R. MALLORY & CO., Inc.
INDIANAPOLIS, INDIANA

Cable Address — PELMALLO

Use
YAXLEY
 REPLACEMENT
 VOLUME CONTROLS

RADIO RETAILING

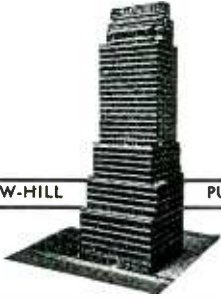

A McGRAW-HILL

PUBLICATION

FEBRUARY 1939

O. FRED. ROST Editor
W. MacDONALD Managing Editor
C. A. NUEBLING Technical Editor
J. H. AVELING Assistant Editor
HARRY PHILLIPS Art Director

Tom Blackburn
Chicago

George Tenney
San Francisco

H. S. Knowlton
Boston

H. W. MATEER
Manager

LEE ROBINSON
Sales Manager

McGRAW-HILL PUBLISHING COMPANY, INC.

JAMES H. MCGRAW
Founder and Honorary Chairman

Publication Office
 99-129 North Broadway, Albany, N. Y.
 Editorial and Executive Offices
 330 West 42nd Street, New York, N. Y.

Cable Address: MCGRAWHILL, New York
 Member A.B.P. Member A.B.C.

James H. McGraw, Jr. President
Howard Ehrlich Executive Vice-President
Mason Britton Vice Chairman
B. R. Putnam Treasurer
D. C. McGraw Secretary
J. E. Blackburn, Jr. Circulation Manager

RADIO RETAILING, February, 1939, Vol. 24, No. 2. Published monthly, price 25c copy. Subscription rates—United States and possessions, Canada, Mexico and Central American countries, \$1. All other countries \$2 a year or eight shillings. Printed in U. S. A. Entered as Second Class Matter, September 8, 1936, at Post Office, Albany, N. Y., under the Act of March 3, 1879. Cable address "McGrawhill, New York." Member of A.B.P. Member of A.B.C. Copyright 1939 by McGraw-Hill Publishing Co., Inc., 330 West 42d Street, New York, N. Y.

Branch Offices: 520 North Michigan Ave., Chicago; 233 Mission St., San Francisco; Aldwych House, Aldwych, London, W.C. 2; Washington; Philadelphia; Cleveland; Detroit; St. Louis; Boston; Atlanta, Ga.

RADIO MONTH, BUSINESS BAROMETER	By O. Fred. Rost	11
PICTURES MAKE DIRECT-MAIL CLICK		13
SALES PHOTOSHORTS		14
WHAT'S AHEAD IN AUTO-RADIO		16
BUSINESS EDUCATION IN A CAPSULE	By Tom Blackburn	18
YOU CAN TAKE IT WITH YOU		20
IRRESISTIBLE SALES TALK	By Caswell Oden	24
RURAL RADIO REPORT		27
LICENSES, PERMITS FOR SOUND	By Robert S. Nash	28
PREVIEW OF NEW PRODUCTS		30
ON THE NEWSFRONT		48
TELEVISION TOMORROW		58
THREE STRIKES ON SERVICEMEN	By Joe Marty	62
INSTALLING 1939 AUTO-RADIOS	By C. A. Nuebling	64
NEW CIRCUITS		66
TRICKS OF THE TRADE		71
SHOP SHORTCUTS		74

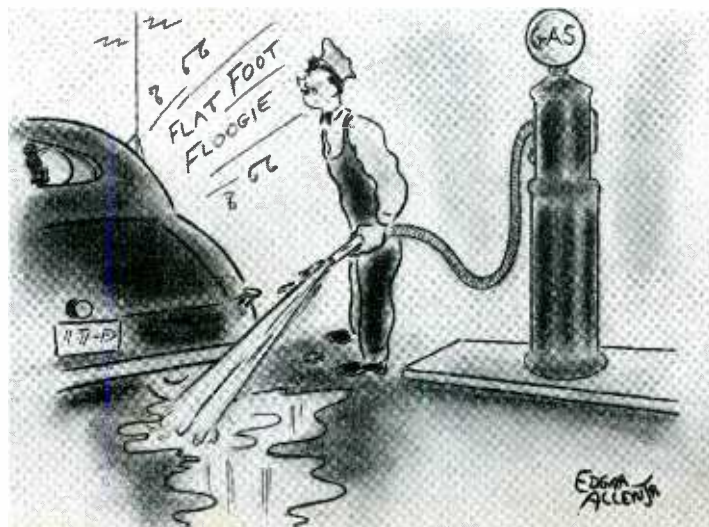

**IN TEST
EQUIPMENT
Successful Service Men**

Stick to fundamentals

Successful servicemen stick to test equipment which measures in fundamental quantities. The reasons are obvious:

Fundamental test equipment *never* grows obsolete . . . eliminates those frequent, costly equipment replacements due to circuit changes. The pointer on a good instrument tells, *exactly*, the true condition in the circuit under test . . . leaving nothing to chance or guesswork. In addition, *it's simple* for any serviceman to check a fundamental instrument for accuracy.

Remember, when buying your next equipment, that all WESTON test units measure in radio fundamentals. That's why WESTON radio instruments remain serviceable for years . . . *never discarded, never idle*, because of changes in receiver circuits. Remember, too, that WESTON instruments are used by practically all leading manufacturers because of their greater dependability . . . greater economy. This name also is *your* best assurance of dependability and satisfaction in radio test instruments. The coupon will bring you complete data.

WESTON
Radio Instruments

WESTON ELECTRICAL INSTRUMENT CORPORATION
581 Frelinghuysen Avenue, Newark, N. J.

Send full information on WESTON fundamental test instruments and WESTON tube checkers.

Name

Address

City State

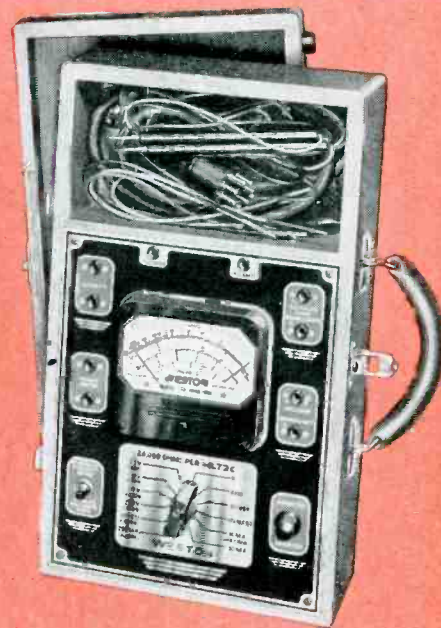

WESTON Model 772 Super-Sensitive Analyzer (sensitivity 20,000 ohms-per-volt). Big, dependable 50 microampere WESTON meter. Broad ranges meet every test requirement for receivers, transmitters, auto testing, television, sensitive relay circuits, etc.

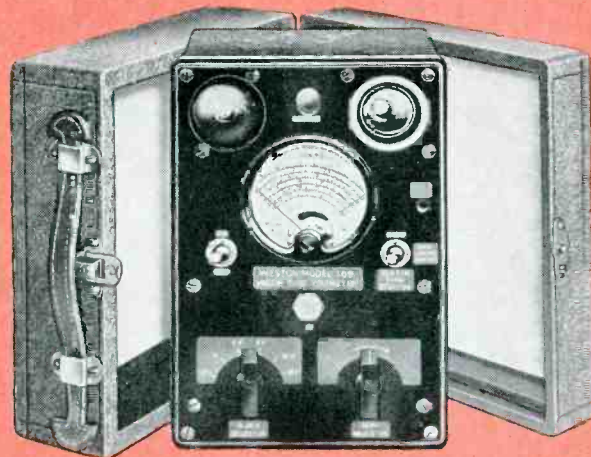

WESTON Model 669 Vacuum Tube Voltmeter. Direct reading, measures gain per stage—r.f. amplitude in oscillator circuit of superhets—all test on AVC circuits, PA systems, and all measurements where high frequency is a factor.



**WESTON 773 "quick-test"
Tube Seller**

Like WESTON fundamental instruments, this attractive counter tube checker has been designed for speed, simplicity and dependability. Minimum number of proved switches assures long, trouble-free operation. Rotator tube chart simplifies test procedure. Makes all tests on all tubes. Impressive looking, in polished wood case. Also available in portable carrying case.

Radio Engineers of the Future
ARE TAUGHT WITH
RAYTHEON TUBES!

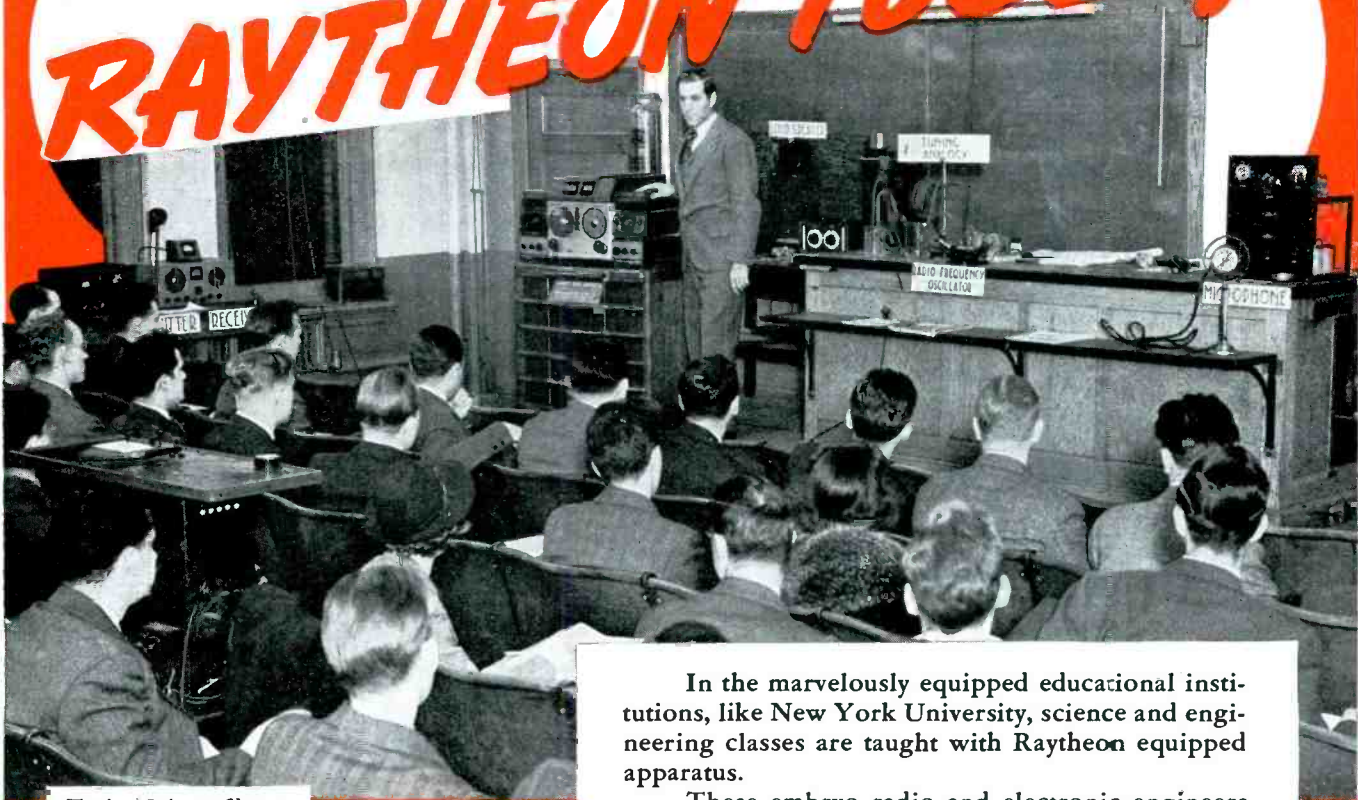

Typical Science Class at New York University attending lecture with demonstrations on Raytheon equipped receivers.

In the marvelously equipped educational institutions, like New York University, science and engineering classes are taught with Raytheon equipped apparatus.

These embryo radio and electronic engineers are instructed with only the finest of equipment, and such equipment deserves the stability and dependability of performance contributed by Raytheon.

At New York University, receivers used for demonstration before 21 science classes are equipped with Raytheon Tubes.

Your customer's radio deserves the same quality performance and you can provide it, without the penalty of higher price, by always equipping with RAYTHEONS.

Successful Dealers and Servicemen—those who are in business to stay, are finding that RAYTHEON tubes are their insurance of the best—for permanent tube profits. And a wise investment. Yet they cost no more than the second-best tube!



RAYTHEON

NEWTON, MASS. • NEW YORK • CHICAGO • SAN FRANCISCO • ATLANTA

"WORLD'S LARGEST EXCLUSIVE RADIO TUBE MANUFACTURERS"

Emerson

WORLD'S BIGGEST SELLING LITTLE RADIO

1939's SENSATION—the "Emersonette"
Leading to Emerson's Prediction of "10,000,000 Sets in 1939 then 15,000,000 Sets Annually!"



TRAVEL



LIVING ROOM



PLAY ROOM



OFFICE



BED-ROOM

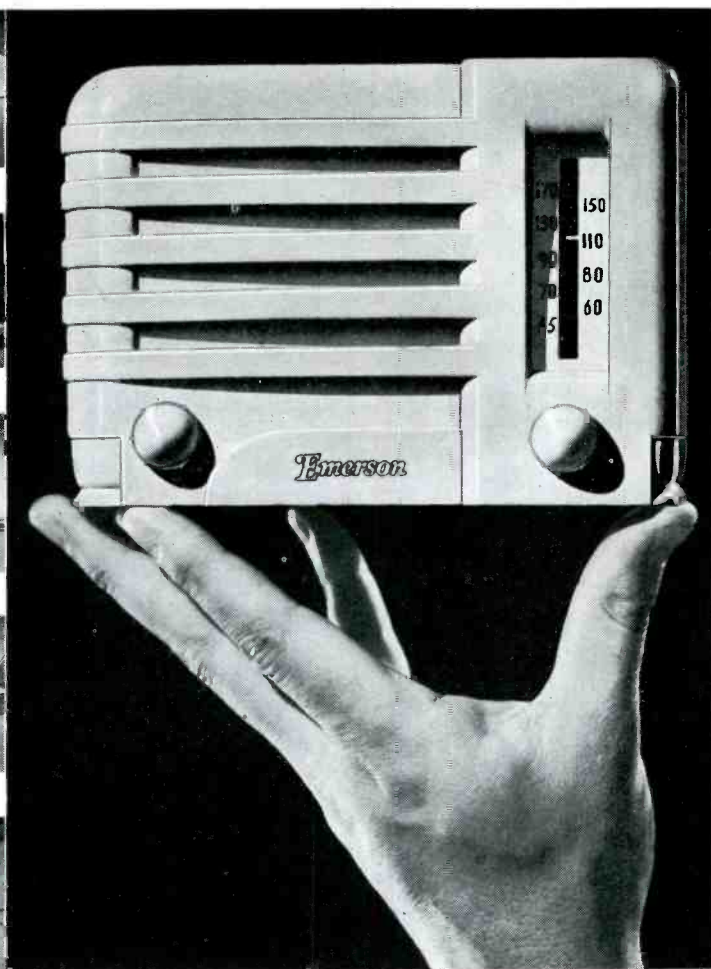

Here is the EXPLOSION the entire radio world has been waiting for! The sensation that will sweep the country—draw the eager-to-buy crowds to your store. The greatest builder of radio sales—in ALL price brackets—you can use!

\$6.95
Complete

IVORY, GREEN AND RED—50c EXTRA

**Packaged in a
 Self-Selling
 Display and
 Shipping Carton**



The smallest PRACTICAL radio ever produced. Choice of FOUR colors—Ivory, Walnut, Green and Red. FOUR-TUBE performance. Amazing sensitivity and tone. 4-inch Permanic Speaker. Illuminated High Ratio Slide-Rule Dial. All advance features!

Sensational newspaper mats—striking window streamers—colorful, self-selling counter displays and other dramatic helps to create a buying surge in YOUR territory. This is only PART of Emerson's constructive program. Write, wire or telephone for complete merchandising particulars.

Ask Your Emerson Distributor for Details

EMERSON RADIO AND PHONOGRAPH CORPORATION, 111 Eighth Ave., NEW YORK, N.Y.
 WORLD'S LARGEST MAKER OF SMALL RADIO

Emerson

WORLD'S BIGGEST SELLING LITTLE RADIO

Backed by Emerson "Multiple Sale" Promotion New, Illuminated "Silent Salesman" — New "DIRECT SELLING" Plans — New Opportunities for YOU!

Following on the heels of Emerson's 100% production and sales increase in 1938—with new, outstanding models, new features, new values—here are irresistible customer inducements—BUILDING dealer opportunities. Here are a FEW typical examples in the mid-season Emerson line:



SELF-POWERED PORTABLE—For instant operation indoors and outdoors Model CE 259 5-Tube Superheterodyne—(7-Tube Performance). American Broadcasts and Police Calls. Automatic Volume Control. Permanent Magnet Dynamic Speaker. Built-in Antenna. Rugged in tan and brown case. Weighs only 15 lbs. Complete. **\$29.95**



Combination Radio and Phonograph — Model BM-242 — With "Miracle Tone Chamber". 5 Tubes (incl. Ballast Tube) AC. American Broadcasts and Police Calls. Electro Dynamic Speaker. Automatic Overload Control. Beam Power Tube. Built-in Antenna. Phonograph: Constant Speed Electric Motor for AC operation. Crystal Pick-up. Tangential Tone Arm. Tone Control. Plays 10-in. and 12-in. records. Hand-rubbed walnut finished cabinet throughout. **\$29.95**



The "Strad" Model CH-256 With "Miracle Tone Chamber". 5-Tube AC-DC Superheterodyne—7-Tube Performance. American Broadcasts and Police Calls. Electro Dynamic Speaker. Automatic Volume Control. Beam Power Tube. Built-in Antenna. Staybent hand-rubbed walnut cabinet —with the beauty of the Stradivarius. **\$19.95**

Watch for
Your
Broadside

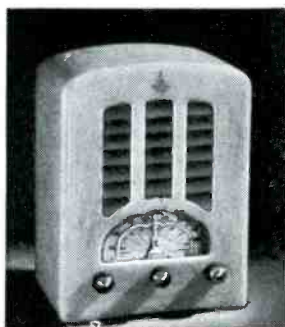

Model BT-245 — With "Miracle Tone Chamber". Choice of color to Harmonize with Any Room Setting: Natural Onyx, Brazilian Onyx, Mexican Onyx, Carnelian Onyx, Flagship Blue. 6 Tubes (incl. Ballast Tube). AC-DC Superheterodyne. American Broadcasts and Police Calls. Electro Dynamic Speaker. Automatic Volume Control. Tone Control. Beam Power Tube. Built-in Antenna. **\$19.95**



Model CH-246 (In Ivory Plaskon) With "Miracle Tone Chamber". 5-Tube AC-DC Superheterodyne—7-Tube Performance. American Broadcasts and Police Calls. Electro Dynamic Speaker. Automatic Volume Control. Beam Power Tube. Built-in Antenna. **\$12.95**

EMERSON "MULTIPLE SALE" PROMOTION

This is EMERSON'S idea—EMERSON'S slogan—EMERSON'S 1939 program for MULTIPLE SALES — for living room, bedroom, kitchen, playroom, office, schools — for traveling and every other purpose.

CAPITALIZE THIS PROGRAM

EMERSON RADIO AND PHONOGRAPH CORPORATION, 111 Eighth Ave., NEW YORK, N.Y.
WORLD'S LARGEST MAKER OF SMALL RADIO

Check THE FEATURES—*Check* THE PRICE TAGS
—AND YOU'LL AGREE . . .

8-TUBE
41-inch console with
Magic Keyboard **\$69.95***

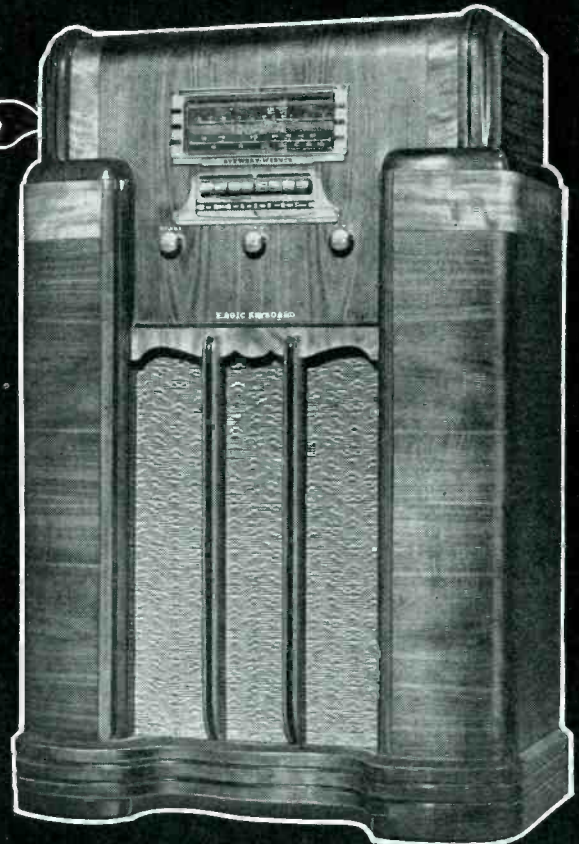

5-TUBE
AC-DC In Molded Cabinet
\$9.95*
In Walnut—In Ivory \$12.95*

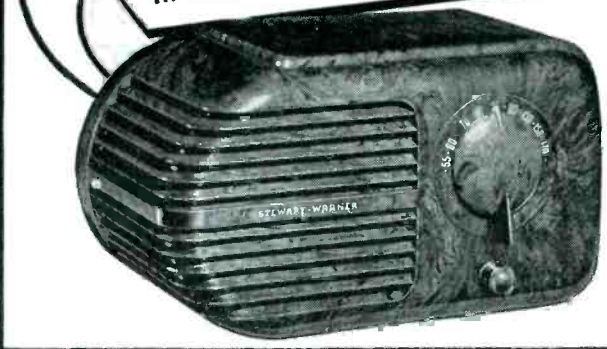

Here are the **HOTTEST** Values in Radio's **HOTTEST** Price Bracket!

9 SENSATIONAL super-values, ranging from the streamlined 7-tube-performance Campus model shown above to the massive 3-gang American-Foreign Magic Keyboard console, make the new 1939 Stewart-Warner line *hotter than hot!* They cover every step-up in the fastest-selling

price bracket with a value you can't duplicate at the price! Every one is a genuine superhet — every one has A. V. C. And every tube is a working tube! If you're looking for value that sells itself, get all the facts now!

**All prices factory list.*



It Has Made Radio History!

The New 1939 Stewart-Warner Senior Varsity—in school or fraternity colors and letters—reaches a new high in personalized appeal. 5 real working tubes—AC-DC superhet.

STEWART-WARNER

Magic Keyboard Radios
Also Sav-A-Step Refrigerators and Ranges

**THE PERFECT
REPLACEMENT TRANSFORMER!**

**Meissner
DOUBLE-TUNED
I.F. TRANSFORMERS**

The ideal replacement transformer! Perfectly engineered! High in quality! Built to hold a plus or minus 5% tolerance—not 25%! Designed for the serviceman or experimenter who demands the utmost in I. F. transformer performance at low cost. Unusually high gain—extremely wide frequency range—and double-tuned with Meissner Low-Loss Ceramic Base Mica Di-electric trimmer guarantees you a superior, more efficient transformer which actually improves the receiver!

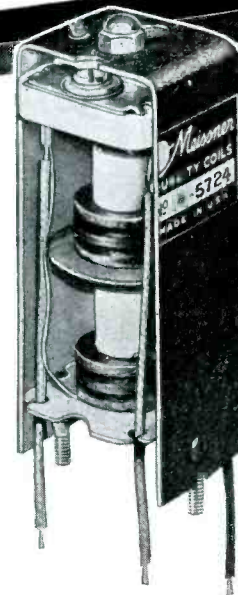

**Eliminate Signal or Code Interference with
MEISSNER WAVE TRAPS**

For those of your customers who are annoyed at intermittent signal or code interference, MEISSNER offers Wave Traps to suit every purpose.

They are connected to the aerial lead-in of the receiver, and are adjustable so that the interfering signal or signals may be "tuned out." Simple and easy to attach—Meissner Wave Traps are priced to make a handsome profit for you.

DeLuxe Dual Universal Wave Trap

A dual wave trap tuning two frequencies. Tunes 400-475 kc to eliminate code signals, etc., entering receiver at the intermediate frequency. Also tunes 550 to 1950 kc for interfering signals in the Broadcast and low-frequency Police bands. Constructed with Ferrocart (iron core) for greater efficiency. Retail List, \$2.65.

NOTE: Other Meissner Wave Traps available for eliminating interference on amateur bands or other wave bands.

SEE YOUR PARTS JOBBER OR WRITE DEPT. R-2 MT. CARMEL, ILL.

**Complete Receiver Kits
I. F. Transformers
Service Parts
Dials • Switches
Tuning Units**



Meissner

MT. CARMEL, ILLINOIS

"A FAMOUS NAME FOR TWO DECADES"



INCREASE YOUR *Money*- KELVINATOR NATIONAL



Sidney Edlund
President Kelvinator National
Salesmen's Institute

★ ★ ★

THE Kelvinator National Salesmen's Institute has prepared a remarkably practical study course which combines sales theory and practice so as to be of constant daily use to retail appliance salesmen.

Mr. Edlund, who has already achieved national prominence through his work in training men in a number of different industrial organizations, writes in: "Not only is this Institute project a 'hot' plan, but the 'student body' looks to me the best timber any organizer could be called on to shape. I congratulate *them* on being tied in with a business whose leader thought up this plan; and I congratulate Kelvinator on having the kind of manpower to insure its success.

"The soundness of the whole set-up is reflected in the Institute's personnel. William Rados, for example, brings an unusually broad experience in man-training and building to the Manager's post. He will have entire charge of the preparation of the Institute's program and maintain constant contact with the salesmen.

"If you were only half as sold on this project as I am you wouldn't need urging to write in now for the Institute's booklet."

Solve the 3 Big Problems Faced by the Appliance Dealer Today

- MAKE EVERY SALESMAN PROFITABLE
- GET GOOD SALESMEN
- KEEP GOOD SALESMEN

ALL THIS MAY SOUND like a big order, but those who have seen the Institute program in its entirety have declared it to be the greatest step forward in sales education ever taken by any manufacturer in the appliance field.

First of all, the Institute is staffed with men of outstanding prominence in the field of sales education.

Second, its one job is to enable salesmen to make more money, for themselves and the dealers for whom they work.

Third, it provides not only a complete selling course—covering products, general salesmanship, and the use of promotional campaigns—but offers every salesman a real incentive to finish the course and profit by its use.

And only those dealers who sell Kelvinator household appliances in 1939 will be able to employ this

effective, three-edged selling tool. Kelvinator invites every household appliance dealer who is interested in making more money in 1939 to send for the free booklet and get the complete story. There will be no charge or obligation.

Just tear off the coupon below, and the booklet will be sent to you.

FORGET EVERYTHING YOU HAVE EVER KNOWN ABOUT "SALES TRAINING"

In a month or two, the entire industry will be talking about the Kelvinator National Salesmen's Institute, and you should know the facts—even though you are not now a Kelvinator dealer.

Talk to your Kelvinator distributor—or to his wholesale man—*now*, about the Institute. Or clip the coupon for a booklet that will give you the entire story. KELVINATOR DIVISION, Nash-Kelvinator Corporation, Detroit, Michigan.



KELVINATOR NATIONAL SALESMEN'S INSTITUTE
14250 Plymouth Road, Detroit RR-2

Please send me a copy of your booklet on the Kelvinator National Salesmen's Institute. I understand that this request places me under no obligation whatever.

DEALER'S NAME.....

ADDRESS.....

CITY.....STATE.....

MAIL
THIS
COUPON
TODAY



Making POWER THROUGH SALESMEN'S INSTITUTE

The Refrigerator That Was 25 Years in The Making

Today Kelvinator is proud to present the climax of 25 years of pioneering achievement . . . the new Silver Jubilee models.

Completely new . . . in design, beauty, and mechanism . . . as revolutionary as the very first electric home refrigerator, which was made by Kelvinator.

Here are just the quick facts. For the full story, talk to your Kelvinator distributor.

The Polarsphere . . . most efficient of all refrigerating units, cost-cutting and trouble-free. Enough power to keep 5 refrigerators cold.

Dry Storage Bin for Vegetables . . . extra storage space for onions, potatoes, turnips.

Steaks and Chops kept fresh and juicy for days in this glass-topped Cold Chest. Holds up to 14 lbs. of meat cuts.

Speedy Cube Release loosens cubes in a flash—by an easy lift of a lever. You get 72 big ice cubes for 1¢ at national average electric rates.

Twin Glass-topped Vegetable Crispers let you see at a glance inside. Salad greens and vegetables are kept garden fresh for days.

New Wider Front increases capacity without increasing size. No more fumbling and groping or knocked over dishes and bottles.

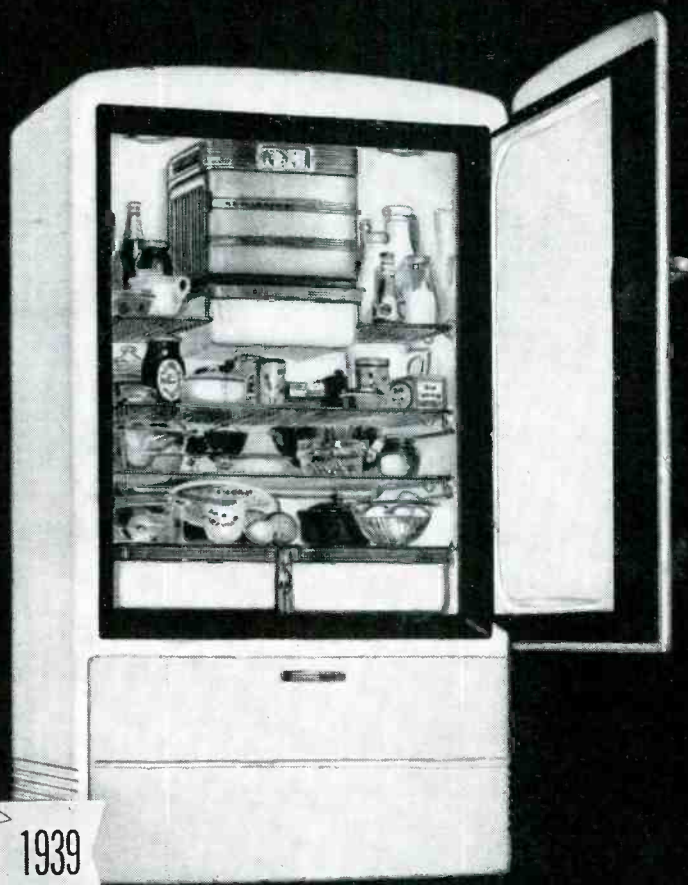

1914

Celebrating the 25th Anniversary of the
Oldest Maker of Electric Refrigerators

1939



Silver Jubilee

KELVINATOR

PHILCO

Dry Batteries

for every purpose

STORE Traffic — *that's what you want!*
And that's what Philco brings the radio and appliance dealers of America in a **COMPLETE** new line of Philco Dry Batteries **FOR ALL PURPOSES**. Radio batteries, as always; but now, in addition, dry cells for every conceivable purpose—flash lights, door bells, ignition, *everything!* There is a tremendous demand for dry cell replacements. They mean quick, easy sales—good related items to attract people to your store . . . **Big Repeat Sale items!**

For over a quarter-century, Philco has been identified as a leader in the battery field. The name **PHILCO**—in the battery industry as well as in the radio industry—always has been synonymous with the highest standards of design, manufacture and dependable service. Today, in its new, complete line of Dry Batteries, Philco offers the advantage of special formulas and improved construction developed in the great Philco research laboratories. Ask your Philco distributor now for a catalog giving full information.

PHILCO RADIO & TELEVISION CORPORATION

The RADIO MONTH

FEBRUARY

1939

Trade Static A system of broadcasting with "frequency" modulation is to receive full scale tests this spring, and unfortunately the event has been over-dramatized as marking the advent of "staticless" radio, which would "outmode" all the radios now in use. **THIS IS NOT THE CASE.**

Retailers may tell their customers flatly and emphatically, quoting *Radio Retailing* as the authority, that the to-be-tested system will in no way whatsoever reduce the usefulness and efficiency of existing radio sets nor, if successful, will it force the scrapping of the present system of broadcasting and reception.

The system that Major Edwin H. Armstrong is preparing to test employs the ultra high frequencies. Even if entirely successful, *the dependable range* of its broadcasts would be no greater than is the present range of television—about 50 miles. It cannot be used on the national networks, and instead—like television—it would require individual, fully equipped, highly expensive stations for each *definitely limited area* of effectiveness.

We may be certain that *when, if and as* a market has been developed through wide adoption of this or any other new system of broadcasting the radio industry will supply sets capable of receiving the standard broadcasts *and any new type*. It has done so in the past, when shortwave, police, amateur bands began to interest the public. It will do so again—whenever technological developments demand such action.

Meanwhile retailers must make it their special duty to reassure a confused public. Whether it be a \$9.95 midget or a \$300 combination radio and phonograph, either its owner or any prospective buyer may have complete confidence that his investment will not be wiped out nor will such set be "outmoded" or made useless overnight through any improvements now in sight.

Buck Fever Buck fever is that physiological phenomena which paralyzes a hunter's muscles and makes it impossible for him to pull the trigger of his gun when confronted with big game at close range. It never appears in the presence of small game.

Right now the radio industry is suffering from a bad case of buck fever.

A year ago economic conditions were going from bad to worse. Hunting for business, the radio industry found nothing but small game in sight. A flood of small sets followed. Prices, and often quality, on higher priced sets were carved down to tragic levels.

Today, there is plenty of big game in sight. Business conditions have averaged 30% better than a year ago, for over 3 months now. Even automobiles, costing many times more than radio sets, are scoring 30 to 45% sales gains.

The retailers, at the sales front, should start by tenaciously trading-up. Larger table models, consoles, combinations are big-game sales.

The manufacturers can back up the dealers by supplying more outstanding values in higher priced models, giving them more effective tangible ammunition for bringing down those big game sales.

Undoubtedly the whole industry would profit if the RMA were to establish some definite MINIMUM STANDARDS of construction and publicize those standards so that the public will demand sets that conform. The tremendous success of the lighting manufacturers with their recent IES campaign demonstrates that such methods appeal and build sales.

Let's shake that buck fever.

E. Fred Rest
EDITOR

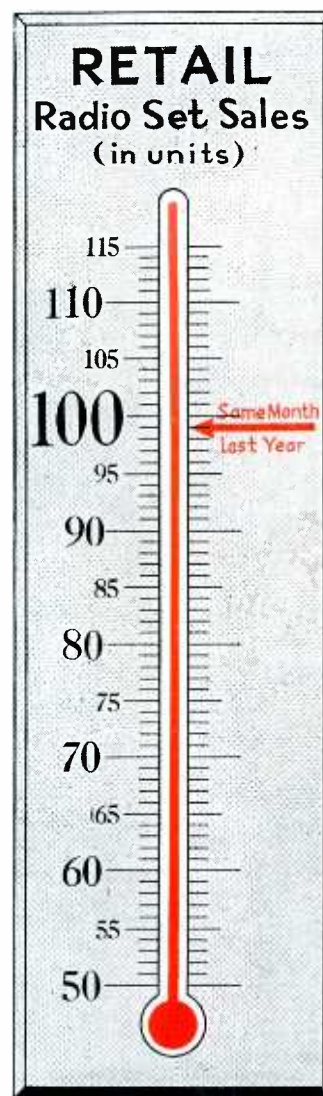

January Sales

Business Barometer

THE January reports of radio dealers show that set sales maintained nearly the same pace as during the holiday rush of the preceding month, so that our barometer which December had pushed through the top—to 125—stands at 118 for January, 18% above last year's January.

Considering that in December the unit sales climbed higher than was generally expected, the fact that January very nearly equalled that record comes as a surprise. It gains in significance when it is remembered that the month which this January has beaten so decisively saw the beginning of the worst epidemic of dumping in recent years, produced abnormally high unit sales.

The dollar value of sales declined from the December level—a quite natural trend—since holiday buying included many higher priced consoles and combinations while post holiday purchases represented low and medium priced sets.

Commenting on the type of sets now being bought, dealers emphasize that the extremely small midgets finally have found a niche in the public mind, for individual use, in children's rooms, kitchens, etc., but not as No. 1 sets.

Improved business conditions are reflected in greater success of "trading up" tactics, the average dollar value per sale actually approaching a profitable level with many dealers who operate in industrial areas.

In most of the agricultural states, sales are holding below the 1938 totals, although the territories involved did not see much dumping last year, and so have less of a sales gap to close. However, in only 5 agricultural states, sales in January were still 15% or more below the same month of 1938 while in 6 such states unit sales were about even, 37 states showed gains.

The Utah Service-Pak consists of this cabinet plus a stock of 79 essential replacement parts.

ANNOUNCING THE NEW

Utah

SERVICE-PAK

YOU SAVE 33%

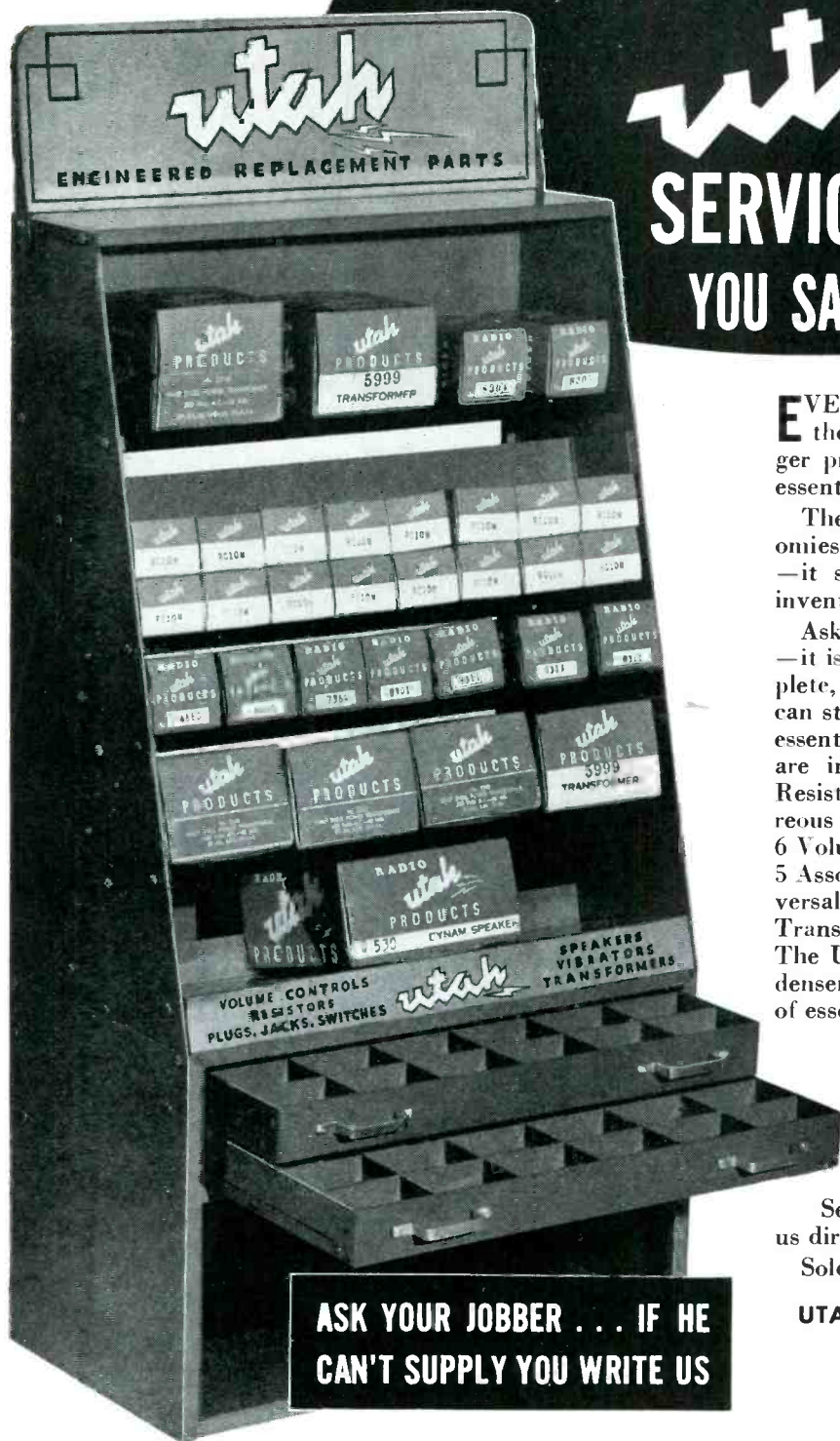

ASK YOUR JOBBER . . . IF HE CAN'T SUPPLY YOU WRITE US

EVERY active service man should have one of the new Utah Service-Paks—for building bigger profits and maintaining a normal stock of essential parts *economically*.

The new Service-Pak provides important economies—it saves time and space—it reduces costs—it safeguards parts—it permits a perpetual inventory to be kept easily.

Ask your jobber to show you the attractive kit—it is 17" x 39" x 10". In one convenient, complete, easy-to-keep-up miniature stock room you can stock practically all your replacement parts essentials. The following high-grade Utah parts are included: 35 Assorted 10-Watt Vitreous Resistors, 6 Assorted 25-Watt Adjustable Vitreous Resistors, 16 Assorted Volume Controls, 6 Volume Control Switches, 3 Assorted Chokes, 5 Assorted Audio Transformers, 3 Assorted Universal Output Transformers, 4 Assorted Power Transformers, 1 5" Electrodynamic Speaker. The Utah Service-Pak also accommodates condensers, vibrators, etc., to complete the stock of essential parts.

No service man should be without this kit of minimum stock essentials. The *Utah Service-Pak Is Priced So Low You Can't Afford to Be Without It.*

Tear this page out as a reminder to ask your jobber to show you the new Utah Service-Pak. If he doesn't have one, write us direct for complete information.

Sold only through recognized jobbers.

UTAH RADIO PRODUCTS CO., Chicago, Ill.
Cable Address—UTARADIO-CHICAGO

DEALER NET PRICE \$2995

Including Cabinet



RADIO RETAILING

FEBRUARY, 1939

PICTURES *Make* DIRECT-MAIL *Click*



SURE-FIRE—No woman can resist saving a shop's address when it is stamped on the back of a photograph of her own home



SENTIMENT—If you're lucky enough to get pictures of your customer's children your address will be immortalized in the family album



SERVICEMAN—Lewis P. Evans uses his camera . . . and his head

DEAR MRS. JONES:

Please accept this picture of your lovely home with the compliments of Evans Radio Laboratory.

We repaired your radio some time ago and we trust it is still working satisfactorily. Please remember us when your radio again needs attention.

Our address is on the back of the photograph, where you can easily find it in your photo album.

Very truly yours,

“A woman can't resist reading a letter when it arrives with a picture of her own home, or someone in her family,” says Lewis P. Evans of Chicago.

“I've received calls two or three years after sending one of my 'photo-letters.' If I'm lucky enough to get a picture of a child, or even the family dog, I frequently hold it for as much as a year before mailing to make it even more effective on arrival.

“My camera goes along with me on every service call. It's the best little salesman I ever had and one of those compact types popularly called 'candid'.”



FOR THE MAN WHO HATES TO WRITE LETTERS
 A personal message on both sides of a 6-inch record for \$1, a 10-inch disc for \$2, is offered by Chapman Radio and Television of Birmingham through store-front signs, placards on its cars and classified newspaper advertising. At Christmas the firm cleaned up, most men impressing their own voices on one side, those of their wives and children on the other. Coaching is usually desirable to avoid stage-fright

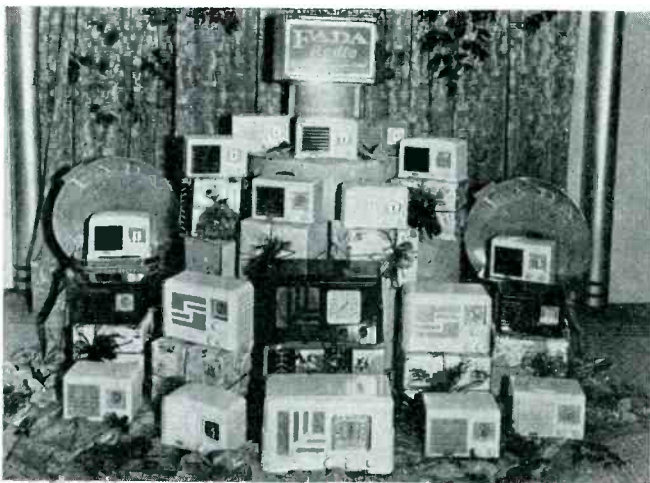

PUSH FOR PLASTICS

From dealer to dealer throughout the territory of Bradburn Radio of Houston, Texas, rotated this mass display for the past two months, pepping up plastic radio sales. Stylist Erin Moseley did the original window design job



A VERY DOGGY WINDOW

Here's the way the R. H. White Company celebrated the 40th anniversary of the Victor trademark: The hand-wound phonograph in the center was built in 1912, while the two table model horn types date right back to the very beginning of the record business

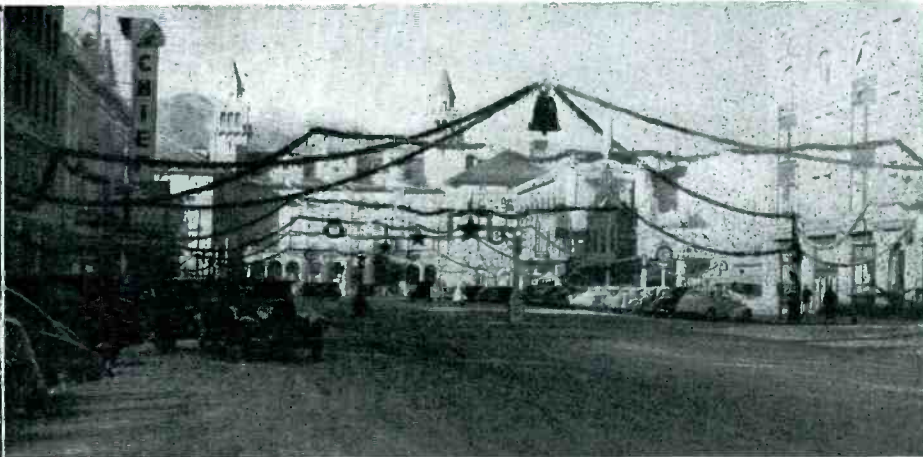

NIGHT AND DAY THESE BIG BELLS PLAY

For the past three years Colorado Springs has installed at its four main street intersections, during the holiday season, huge 6 by 4 ft. wooden bells covered with evergreen and lights

and concealing large speakers. Regular afternoon and evening music is fed to all four from a single sound amplifier, and people come from miles around into the shopping district

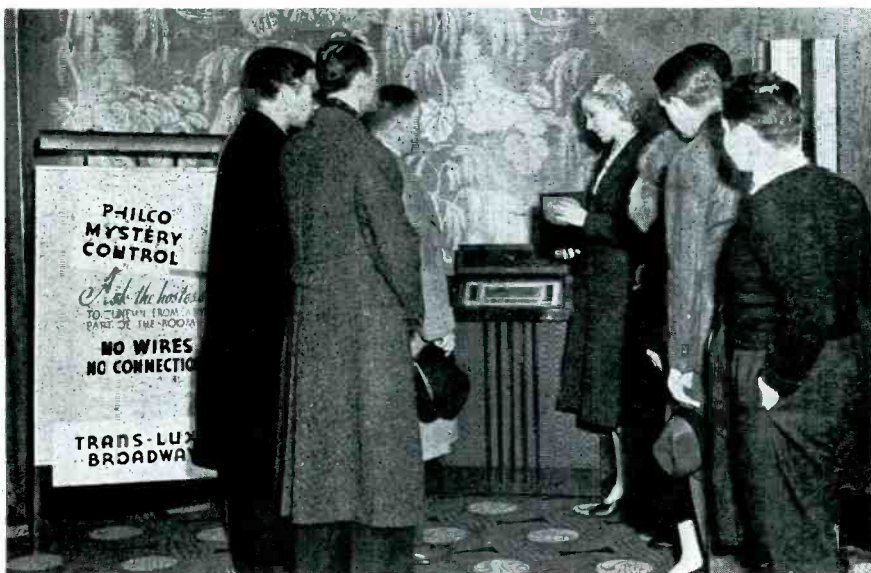

SO WHO WATCHES THE MOVIES?

Publicity tieup between a set manufacturer and a New York news movie house pleased both, apparently intrigued the customers. In the lobby was the remote-controlled set, a blonde, free cigarettes, coffee. On the screen was a short trailer plugging the model.



HERE'S ONE PLACE LIKE HOME

Curtains, venetian blinds, a rug, easy chairs are all employed in the audition room at Wood's, New Orleans, to give records the homelike atmosphere they need to sell themselves. Swanky phono-combinations too are aided by such surroundings, helps this dealer "sell up"



WHAT'S AHEAD in AUTO-RADIO

CONVENIENCE—Quickly identified in the dark, are six station pushbuttons and three auxiliary controls as well as the conventional dial on one 1939 (Philco) model for all are indirectly illuminated. Equally interesting is a mechanical arrangement in another line (Pontiac) which permits instant front-of-panel pushbutton adjustment to any station tuned in on the drum dial

UP the sleeves of manufacturers who will not announce 1939 auto radio lines until next month, may be features more important to the trade than pushbutton control but we doubt it. For pushbuttons, merely convenient in home receivers, are even more logical in cars where the operator cannot safely remove his eyes from the road for any appreciable time. Convenience and safety add together to provide the retailer with a particularly strong sales story.

In lines already seen, pushbuttons are featured so universally that we take little chance when predicting that headlining of such tun-

ing systems by most manufacturers this season seems certain. It will be the rule rather than the exception, we think, to include conventional dial tuning as well, especially in medium and upper price bracket sets. And while receivers using just pushbuttons, or just dials, are no doubt needed to meet certain consumer preferences and will be included to round out manufactur-

ers' lines, it seems likely that those incorporating both will account for the bulk of the season's volume.

An interesting "throwback" is noted with respect to packaging. Early auto-radios were generally in two or more units. Then single unit jobs whose chief virtue was low price appeared and for a time dominated the market. This season it appears that really good radios are available in both types. Most lines we have seen incorporate not only single unit receivers in medium as well as low price brackets but also include models in which chassis project built-in controls from beneath the car's instrument panel and at the same time use external speakers. The wedding of easy installation, not so long ago virtually monopolized by cheap designs, and



SPECIFICATIONS NEXT MONTH

On the market unusually early and in time for this issue came a sufficient number of 1939 receivers and accessories to indicate probable design trends.

These are herein described for the benefit of retailers anxious to formulate plans for early Spring campaigns. And elsewhere in this number technical details are diagrammed.

The season's new car equipment is by no means covered in this preview. The March issue will picture additional sets and antennas in its New Products columns and, in addition, will contain a complete, detailed tabulation of auto-radio receiver specifications.

COMPACTNESS— Clamped together like two halves of a walnut is the tuner chassis (Motorola) of one well streamlined and easily serviced two-unit job. Cleverly engineered for simplicity of installation while retaining visibility and accessibility of controls are two more (Arvin, RCA-Victor) early offerings. Provided with an extremely simple mounting bracket is still another (Howard) set. Note universal use of pushbuttons

good quality, appears to us to be a happy union which will help dealers hold profit up.

Interesting, too, is the announcement by several manufacturers of pushbutton panels designed to match instrument boards of new cars. In most instances, chassis are still remotely controlled in such installations.

“Loctal” tubes seem to be cutting quite a swath in the auto-radio business (technical details of this and other features available at presstime appear elsewhere in this issue) but until complete line specifications are made available for March publication we cannot say just how wide.

AMONG auto-radio set and accessory makers ready to talk about merchandise about to be offered in this field, we pick up the following scattered news which is necessarily sketchy at this early date but interesting, nevertheless, to the trade.

Out at *Motorola* the keynoted feature appears to be a “Boost-O-

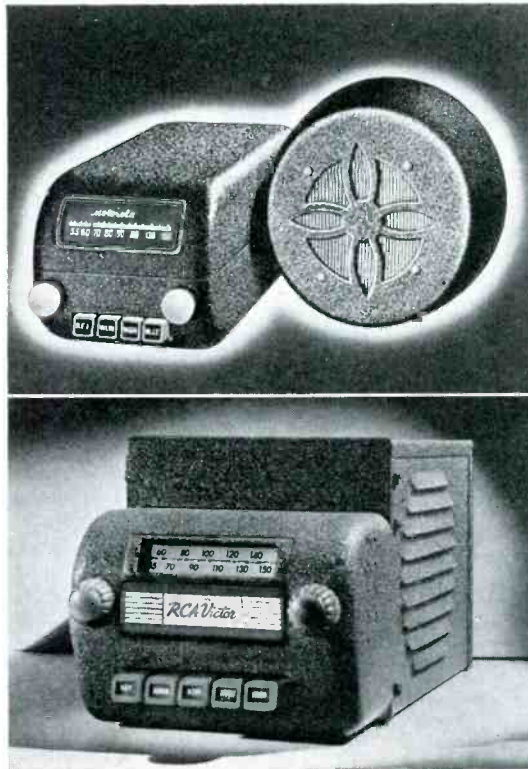

Matic” circuit which greatly improves antenna stage gain in this firm’s new receivers. Motorola will also have two completely separate receiver lines, we understand, one comprising standard models for installation in any car and another provided with special matching plates for particular instrument panels. Prices range from \$24.95 to \$69.95. . . . *Arvin* models announced to date run from \$22.95 to \$49.95 and Noblitt-Sparks engineers tell us

that the famous “Phantom Filter” has been improved to an even greater efficiency than last year. . . . Interesting idea incorporated in the only *Philco* we have heard about to date is a pushbutton control panel which may be mounted right in the set chassis itself or used at a remote point. . . . From the *Howard* plant comes a two unit model with a chassis of extreme “thinness” for easy installation in crowded driving compartment areas. . . . *Admiral* is getting into production with a 5 and a 6-tube job, the first at \$24.95 and the second at \$39.95, one a pushbutton and the other a remotely tuned type.

Nor have accessory makers ready with new auto-radio devices at this time been asleep. *RCA-Victor* ties in with the automobile-maker’s ballyhoo about noise insulation by bringing out a whip-type antenna whose mounting bolts are covered with metal shields to avoid both mechanical and electrical noise. . . . *Radiart’s* latest innovation is a cowl type antenna which mounts under the car’s hood, eliminates the necessity for drilling a finished body panel. . . . *Consolidated’s* complete 1939 line of car antennas of all types puts particular stress on rust, rattle and weatherproof whip and

(Continued on page 59)



APPEARANCE— Whip type antennas of which this one just installed in a firechief’s car (Top-All) is typical are certain to see increased use this season. They mount at the rear, on a door hinge or, as in one case (Col-Mar) telescope out of the way when not in use and are automatically raised in front of the windshield at will

Business Education in a CAPSULE

By TOM BLACKBURN



Feeling that a dealer can throw more profits out the back door through poor business management than any distributor can bring in the front in the shape of salable merchandise, Frank W. Greusel of Milwaukee has hit upon a unique method of aiding his trade to stop leaks.

He realizes that dealers busy about their day's work do not have time to take elaborate courses in accounting and management. In fact, they do not often have leisure even to read books on the subject. So, Frank Greusel is sending them letters touching on different phases of the subject, business education in capsules, so to speak.

The following are samples of his educational letters:

Cost of Doing Business

In order to prosper in the Home Appliance Retail business, income from sales must exceed the items of expense. No matter how large or small a business may be there must be a proper relationship between these two items.

Expressed in percentages, the average cost of doing business is 30 per cent, ranging from 25 per cent to 35 per cent depending upon the type of operation conducted. Certain combinations of retail items lend themselves to low cost opera-

tion, but all dealers are not fortunate enough to enjoy this low overhead, so 30 per cent may be accepted as average.

This expense is made up of:

- Salaries (owners)
- Salaries (employees)
- Advertising, Sales Promotion
- Insurance (all kinds)
- Stationery and Office Supplies
- Heat, Light and Power
- Telephone and Telegraph
- Postage
- Local, State and Federal Taxes
- Contributions to Charity—
- Association Dues
- Auto and Truck Expense (delivery)
- Rent (although you may own the building)
- Social Security Tax—
- Unemployment Compensation
- Bad Debt and Collection Expense
- Depreciation on furniture, equipment, signs, etc.
- Merchandise Depreciation
- Maintenance, painting, cleaning, etc.
- Miscellaneous—and for good measure, the much disputed charge of interest on your invested capital.

You may or may not know that large department stores—well managed—have an average overhead expense to sales of 35 per cent.

In our next letter we will tell you something about the relationship of price-cutting and excessive trade-in allowances to overhead and how it may determine either profit or loss.

Our reason for writing you as we have is selfish! *We want you to*

be a better businessman so you may be a better customer.

Sales Volume and Net Profit

Too many dealers pay too much attention to mere volume of sales. Too many dealers go broke doing so.

Cut-prices—excessive trade-in allowances—discounts for cash—premiums, and other inducements, bring easier and larger sales volume—but do you want this *plus* business?

Vic maintained that *confidence* and *goodwill* was the dealer's greatest asset and even though it takes years to build it and requires fair treatment every day to hold it, yet it is a dealer's greatest assurance of continued, profitable patronage.

Al, who has had years of experience as a retail salesman, very

DISTRIBUTOR GREUSEL

Prepares potent pills of wisdom



forcefully stated that in his judgment the salvation of the specialty appliance dealer was *intelligent selling through better product knowledge*. His exact words were, "With keen competition from trained sales people employed in national retail organizations, it is imperative that our neighborhood dealers not only match this ability but, also, take full advantage of every local opportunity available, such as *personal acquaintance, friendly interest after sale is made, and dependable service on guarantee.*"

I necessarily had to agree with

each one of them, agree that all of their ideas were important, but, that it requires *even more* today to be a successful merchant.

Price-Cutting

Don Graham, our Credit manager, dashed into my office a few days ago with this message—"I would like to put over a thought in this series of educational letters that you are sending out to our dealers that I think is important to them—"

Manufacturers of *appliances* for the *home* spend millions of dollars annually to cooperate with dealers by preparing excellent copy, both national and local, and also many sales promotional ideas that the neighborhood dealer can take advantage of at low cost. It is distinctly to his benefit to put all of this material to work.

Personalities

Several days ago, I listened in on a Sales Department discussion on the above subject between Jimmy McCuen, Margaret Reuter, Vic Kreft and Al Schuele.

Jimmy insisted that the store could *develop a "personality"*—*the same as an individual*—that it could be made to reflect intelligence, hospitality and dignity.

Margaret, with her feminine ideas, was of the opinion that *neatness, attractiveness, cleanliness, and orderly display* was all important. She stated, "A store does not necessarily have to be large to be impressive; it is equally important to the small store that it be kept neat, attractive, and clean daily—with competent salespersons aiding the customer in his or her selection."

Moral: Make sales at proper prices.

Proper Advertising

Many dealers do not know how much they can afford to spend on advertising so they approach this most important angle of their business with uncertainty and doubt.

While some dealers budget their annual operations as accurately as they can, a great percentage do not, and they find themselves overspent and unable to meet all of their obligations promptly.

It appears sound for a dealer to spend approximately 3 per cent of his annual sales for advertising. In other words, if he does a volume of \$35,000.00, he should spend ap-

proximately \$1,000.00. Keep in mind, please, at all times that this recommended advertising commitment is based on sound selling and does not allow for any price-cutting or excessive trade-in allowances.

A heavy percentage of a dealer's total advertising expenditure should be committed during the early months of the year, allowing about one-third of the amount remaining for extra effort if an unusual opportunity should present itself.

Advertising efforts should be well planned . . . should be regular and consistent and carried on for definite periods—arranged for in advance so as to be flexible enough to either contract or expand depending on current conditions.

Let's analyze the operation of a neighborhood retailer doing an annual business of \$40,000.00.

Sales at list	\$40,000.00
Amount of net sales	40,000.00
Cost of merchandise (average discount 35 per cent)	26,000.00
Gross Profit on sales	14,000.00
Overhead Expense (average 30 per cent)	12,000.00
Net Profit	2,000.00

Mr. Retailer may think he can make more money by securing larger volume at 5 per cent in profit through trade-ins etc.—but here's what happens:

Sales at list	\$52,632.00
Amount of net sales	50,000.00
Cost of merchandise (average discount 35 per cent)	34,210.00
Gross Profit on sales	15,789.20
Overhead Expense (average 30 per cent)	15,789.60
Net Profit	Loss 80

Mr. Retailer may become real ambitious and set out to do a big job at a 10 per cent cut in profit through trade-ins etc.—but here's what happens:

Sales at list	\$66,667.00
Amount of net sales	60,000.00
Cost of merchandise (average discount 35 per cent)	43,335.55
Gross Profit on sales	16,664.45
Overhead Expense (average 30 per cent)	20,000.10
Net Profit	Loss 3,335.65

We have not pointed out that *more or additional capital* is required for you to break even or lose money.

Few dealers realize what is involved when they cut prices to draw extra customers into the store. They may reason like this . . . "Let's see now, this month I'll take those Blankety Blank Radios that

(Continued on page 60)

You CAN Take It

Many battery portables coming on market for Spring and Summer sale. Use lower battery drain tubes, built-in antennas. Weight under 20 lbs.

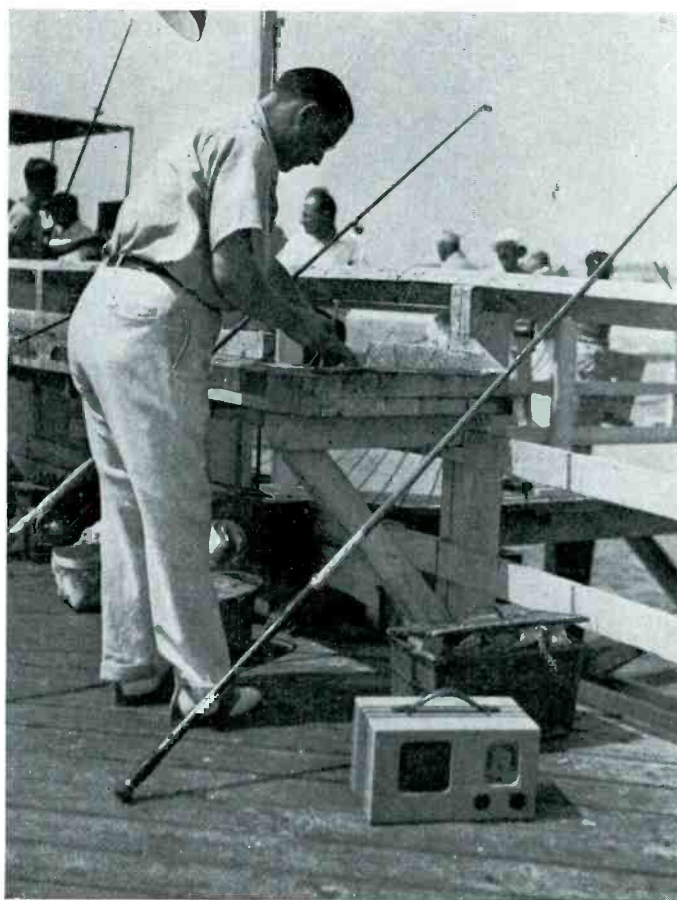

Philco



RCA Victor

TO Omar Khayam's tempting trilogy . . . "A loaf of bread, a jug of wine and thou" . . . modern science now adds a fourth for the man who likes to get away from it all and lie out under a figurative tree.

Battery type portable radios, often offered but never before concertedly pushed by virtually the whole industry, are coming on the market in such numbers that many spring and summer sales supplementing home and auto-radio set volume are certain. A trend of major importance to the trade is seen.



Westinghouse



Emerson

With You!

Keynote of the drive for extra business is the use of new battery type tubes with phenomenally low drain. They run on $1\frac{1}{2}$ volts of "A" battery, generally drawing less than $\frac{1}{4}$ ampere per hour from this source, usually draining under 15 milliamperes from a 90 volt block of "B's".

Despite this extremely low drain new portables turn out about $\frac{1}{4}$ of a watt of audio power, ample for the purpose.

Equally important in portable design is the almost universal incorporation of built-in antennas. If the user wants more "sock", or treks out into remote regions far, far away from powerful broadcast stations, a regular antenna and ground may usually be attached to provided binding posts for increased pickup.

Speakers are usually permanent magnet dynamics, dials are often recessed for protection against knocks during transportation. In some instances protective covers are provided.

Carrying handles are built-in and with total weight including batteries under 20 lbs. (average 16.3 lbs.) extreme portability is obtained.

Weatherproof airplane luggage cloth finish that looks well, appeals to travellers who know good baggage and can stand the gaff ideally suits this new merchandise.

No matter where you go, speaking of radio, you *can* take it with you!

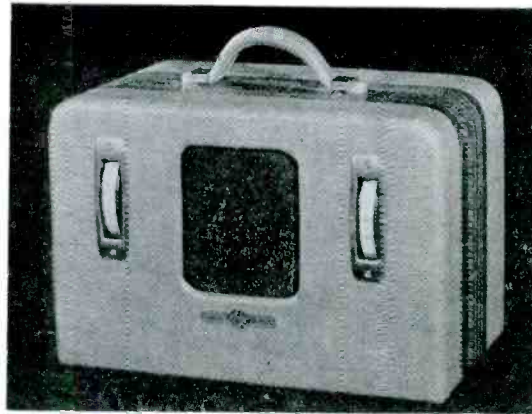

General Electric

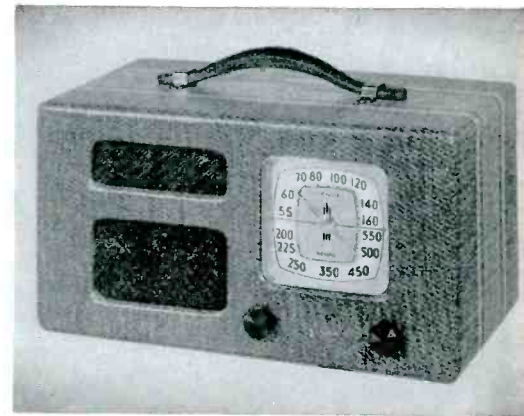

Fada

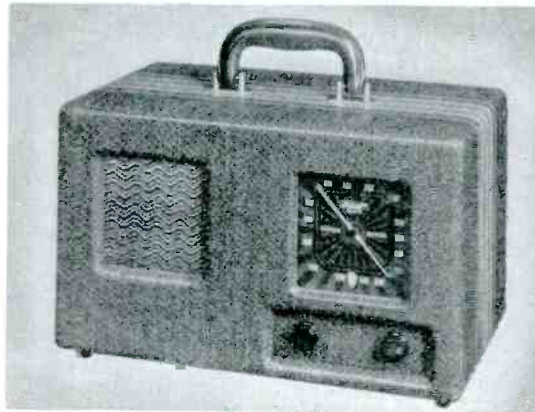

Pilot



Stewart-Warner



Majestic



Sentinel



Admiral



Troy

The BIG News Is Out!
PHILCO ANNOUNCES
NEW PRODUCTS and PLANS
*to put profits in every month
for the Appliance Dealers of America!*

Philco distributors have just heard the full details of the new Philco All Year 'Round program—sensational profit news for the Radio and Appliance Dealers of America. A new, unified, twelve months plan of advertising, merchandising and sales. A plan that creates new economies and new profit opportunities that have never been possible for dealers before! Your Philco distributor is on the way home now bursting with the news . . . the news of the radio models, the refrigerators, the air conditioners and all the other products now brought together into one profit family. You'll hear it all soon. Before you complete your plans for Spring profits, stop, look and listen to his story!

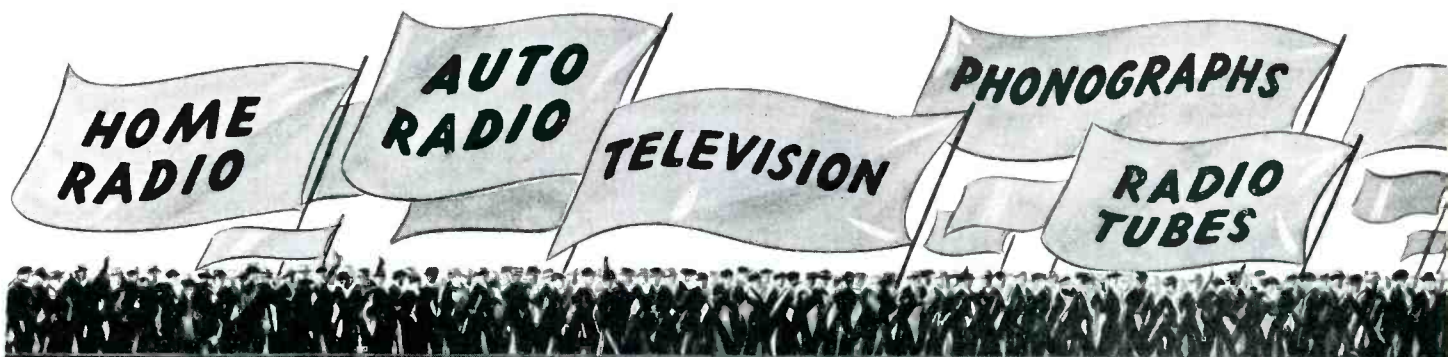

PHILCO ALL

PHILCO RADIOS

New radio models . . . engineered and styled to put new life into the Spring business of every Philco dealer . . . priced to meet every purse. Stunning consoles in impressive new cabinets. New Transistones in attractive table models . . . every one approved by Underwriters' Laboratories. SAFE for your customers' homes and children, SAFE to sell. New portable radio and radio phonograph combinations—*naturals* for Summer selling! New wireless record players

—a complete new line of sensational values in Philco Auto Radios—yes, a *ream of news* for Spring radio profits!

And the Philco radio advertising campaign continues! Full page ads in the nation's leading magazines, ads that tell the news of the new models as well as the quality message of Philco engineering. New promotional material is ready for Spring sales campaigns. Your Philco distributor will give you all the details.

CONSERVADOR REFRIGERATORS

Philco, the quality name in over 11 million American homes enters the field of refrigeration! That, alone, is sensational news! But not with just "another" refrigerator, not with hidden features and laboriously created sales arguments . . . a refrigerator that is NEW, DIFFERENT and BETTER . . . with a feature that is *instantly seen, instantly demonstrated and instantly appreciated*. The new Conservador Refrigerator with the Inner Door . . . 26% more

quickly usable space . . . twice the convenience . . . and the first refrigerator ever made where you *really use, easily and naturally, all the space you buy!* A quality product with *every* worth while feature of any good refrigerator—PLUS the Conservador. And it's all backed with a complete, aggressive national advertising, merchandising and promotional campaign. It's part of the Philco All Year 'Round plan. Your distributor will give you the whole story!

YORK COOL-WAVE AIR CONDITIONERS

York, leaders in air conditioning, and Philco, leaders in appliance merchandising, combine to bring a new industry to the Appliance Dealers of America. Now, at last, portable air conditioning, *as low in price and as easy to install as a good radio!* No technical knowledge required, no complicated installations, no plumbing, no wiring, no alterations. And now a complete line that fits any size room—enables you to sell genuine air conditioning as low as \$15 down.

It's the most sensational profit opportunity that has come to the appliance dealer in years. Full profits . . . NO TRADE-INS. A vast, untouched market is waiting, eager to buy. The dealer that just *skims the cream* this season will pocket a handsome profit. The plans are all ready . . . York Cool-Wave is a big part of the Philco All Year 'Round program. Get the full details from your distributor and get into this profitable business NOW!

PHILCO DRY BATTERIES

Store Traffic—that's what you want! And that's what Philco brings the Radio and Appliance Dealers of America with a COMPLETE new line of Philco Dry Batteries FOR EVERY PURPOSE. Radio batteries, as always; but now, in addition, dry cells for flash lights, door bells, ignition . . . for every purpose. There is a tremendous demand for dry

cell replacements. They are quick, easy sales . . . they bring repeat business . . . attract people to your store and give repeated opportunities to sell higher-priced merchandise.

Remember—Philco brings to this field more than a quarter-century of experience in building quality batteries. Ask your Philco distributor for a catalog giving full details.



YEAR 'ROUND

The IRRESISTIBLE

By CASWELL ODEN

LAST month we sold Mrs. Jones our "Coldfood" electric refrigerator *Itself* and the *Convenience*. This month we'll give her our *irresistible* reason why she should buy it.

This, of course, consists of computing the actual (net) increase (or decrease) in her budget which will be effected by the purchase of the box.

Now we knew exactly what the figures would be as soon as we found out how much she was spending for ice, but we take out our pencil and paper and figure with her anyway. We figure *with* her—and this is very important. We don't figure it ourselves, and then tell her the results. She's going to find it hard enough to believe even when *she* does the figuring—with our assistance.

So, with our heads together (but not too close together), we merely add the monthly cost of the box to its cost of operation, and then deduct her monthly ice bill (year 'round average) plus what she'll save on her food bill each month—which we compute.

Yes, that's all we do. But it is the *way* we do it that usually sells the box for us.

The Way to Tell It

And this, emphatically, is the proper "way" to do it:

With both the ice bill and the saving on the food bill, we deliberately give ourselves the worst of it. And it is this *giving ourselves the worst of it* that gets Mrs. Jones, makes her *believe* our story.

Not only can we *afford* to do this, but we actually *profit* by doing it. In the first place, our story is going to be good enough anyway—and be believed. In the second place, if we take all the *best* of it our story will be *too good*—and *not* believed.

You know as well as I do that we can manipulate our figures in such a way that, no matter how little Mrs. Jones spends for ice, we can have her *saving* money, actually

decreasing her budget by buying the box—by merely using an exorbitant saving-on-food-bill figure. But this being able to get a valuable piece of merchandise for nothing, or less than nothing, sounds entirely too fishy, and few women are inclined to believe it. Even in a case where we know, from the circumstances, that the lady will actually get her box for less than nothing (net), we have one dickens of a time making her *believe* it.



GET INTO THE KITCHEN—"Where would you put the new electric refrigerator?" you ask. And the housewife leads you to the kitchen where you discuss convenience and the power outlet just as if it was *already* sold . . . as it probably soon will be

I have found that the story sounds much better and is more readily believed by the prospect if we let the box actually *cost* her a little something. (Not much, though! About a dollar a month is a good figure.)

Naturally, where the ice bill is high, we have no trouble with the saving on the food bill. Where the ice bill is low, we simply spread the food bill saving on a little thicker. Always winding up with a slight cost to the consumer. Letting her break even sounds fishy. But we may do that, once in a while—if we think we have a lady

who could go for such a bargain. At any rate, our argument is going to be irresistible even if the box *does* cost a little something, net.

Warming Up Cold Figures

Let's say that the monthly payments on Mrs. Jones' box are \$6.00, and we have already told her that the cost of operation will average about 75¢ a month. We have \$6.75 from which to deduct.

We know she spends 15¢ a day for ice, but she tells us this is for only six months of the year, so we *give ourselves the worst of it* and compute her ice bill at 7½¢ a day the year around, or \$2.25 a month. This deducted from the \$6.75 leaves \$4.50, and the thing for us to do, then, is compute the saving on her food bill at about 87¢ a week, or \$3.48 a month. This may or may not amaze her. But even if it does she won't be amazed long, because we hold forth something like this:

"You know, Mrs. Jones, I could paint a very rosy picture for you here, but I'm trying to tell you the truth. Take that 15¢ a day that

DUCKING MALE OBJECTION—Get her to agree to come to the door *herself* when you call back later to sell the husband. This will avoid a last minute turndown by the tired male who may be grumpy after a hard day at the office . . . and he'll calm down later



Sales Talk

you're spending for ice. Most refrigerator men would deduct \$4.50 a month right there—hoping you'd forget the fact that you don't buy any ice during the winter. And they'd be right, too, as far as the summer months are concerned. But I didn't do that, because I'm trying to give you the *correct* figures.

(It is our taking the worst of it here that convinces Mrs. Jones that we'll take the worst of it on the food-bill saving figures too.)

"Now let me show you something about estimated savings on food bills as computed by the *manufacturers* of electric boxes. I'll show you that, if anything, my figure is too low."

We open several of our many catalogues. One of them states that the saving, for a family of five, will average about \$10.00 a month. Another claims a saving of about \$2.00 a week.

"See that, Mrs. Jones?" we wave. "Gross exaggerations. That's why I don't *use* those figures. I wouldn't try to make *anybody* believe that, much less an intelligent woman. You know and I know that nobody is going to save that much on food by getting an electric refrigerator. Why, if we listen to what they tell us in these catalogues, we'll be putting money in the bank as soon as we get our electric box!

(Sorry, manufacturers, But Mrs. Jones, and every other woman I ever talked to, thinks your figures are exorbitant. And if we can convince them that *our* figures are right—and do it *best* by piously squawking about how high *your* figures are—you don't mind, do you?)

"Of course, it's only natural. They make the boxes, and they want to sell them. But I don't use their figures. I'm using Government figures. They were included in a survey that had something to do with the Pure Food Laws. (They weren't, but Mrs. Jones won't look it up.)

"Now, after all, Mrs. Jones, the Government doesn't care whether



CLOSE, BUT NOT TOO CLOSE—With your heads close together figure costs *with* the prospect. She's going to find savings hard enough to believe even when *she* does the figuring . . . with your assistance

you buy a box or not. So when I tell you that the saving, for a family the size of yours, will average about 87¢ a week, you can be pretty sure that my figures are right.

(Mrs. Jones believes us, now, but we've still got to explain *why*.)

Dramatizing Food Savings

"How is this money saved? It is saved by cutting down or totally eliminating spoilage. By buying in any *quantity* you wish, with the assurance that what you buy will be kept fresh until you are ready to use it. And by buying at any *time* you wish, with the same assurance, thus taking advantage of bargain prices.

"Let's take a look at the first saving, on spoilage. Now I'm not trying to tell you that you're not an economical housewife, Mrs.

THIRD of a REFRIGERATION Series

JANUARY:

"Selling the Box Itself"

DECEMBER

"A-B-C of Refrigeration Salesmanship"

Jones, but you know that there are many things which you throw out now that you wouldn't if you had an electric box. Isn't that true? (She nods, in nineteen cases out of twenty.)

"It's only natural. You can't help it. You've got a box in which the temperature is constantly fluctuating, going up and down. When your box is full of ice, you may have fair refrigeration. But when the ice is low, when it's almost time for the ice man to come and track up your nice clean kitchen floor again, then what? Then is when you've got practically no refrigeration at all, and then is when your food spoils.

"Now let's look at the second way you save, by buying in any *quantity* you wish. What does this mean? Well, take strawberries, for instance. You know how they're usually sold. When the huckster comes by, it's ten cents a quart, two for fifteen. Always cheaper if you buy more. Isn't that true, Mrs. Jones? Only a nickle—but these small savings count up.

"You'd be surprised how many women with ice boxes buy in small quantities, and therefore pay higher prices, simply because they're afraid

(Continued on page 60)

RCA's SERVICE TO *Motion Pictures*

YOU enjoy movies more because of radio. Radio helps make movies so interesting that the annual attendance in the United States equals twice the population of the world. Yet few realize that the reproduction of voices and the whole range of sound that makes pictures live—is a laboratory product based on research in radio and sound.

Because the recording and reproduction of sound involves so many principles which have grown out of radio, research in RCA Laboratories has been, and continues to be a big factor in creating finer motion picture sound entertainment. This work is closely connected with research and actual practice in making Victor Records and operating the National Broadcasting Company.

Here is another example of the way in which RCA uses research to develop services of benefit to the whole world. It was research that built the world-wide radio message service of R. C. A. Communications . . . research that developed the RCA "direction finder" and other safety devices for ships at sea which the Radiomarine Corporation of America supplies . . . research that has made RCA Victor Radios and RCA Victrolas outstanding in the field of radio and record entertainment.

Because the Radio Corporation is active in every field of radio, the sum total of its research benefits every person engaged in the sale of radio products. The efforts of RCA make radio more attractive to those who listen and thereby improve the opportunities of those who sell radio instruments. This is in line with the RCA policy of making radio serve more people in more ways and serve them better in all ways.

Listen to the "Magic Key of RCA" every Sunday, 2 to 3 P. M., E. S. T., on the NBC Blue Network.



PHOTOPHONE
RCA
HIGHER FIDELITY SOUND

RCA Photophone plaque—the sign of the best in sound reproduction.



Recording sound through Directional "mike," one of the outstanding microphones developed by RCA Laboratories. RCA microphones are used in film and radio studios all over the world.

RCA Contributions to Three Important Phases of Making Talking Pictures



The sound reaches the theatre audience through RCA Photophone Reproducing Equipment such as is in use in more than 5,000 theatres. To insure good sound the movement of the film must be at a perfectly constant speed. RCA engineers accomplish this by the unique and ingenious rotary stabilizer.

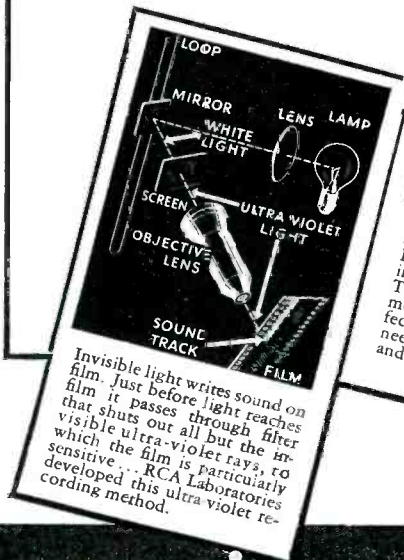

Invisible light writes sound on film. Just before light reaches that it passes through filter which shuts out all but the visible ultra-violet rays, to which the film is particularly sensitive . . . RCA Laboratories developed this ultra violet recording method.



Radio Corporation of America

RADIO CITY, NEW YORK
RCA MANUFACTURING CO., INC. RCA INSTITUTES, INC. NATIONAL BROADCASTING COMPANY
RADIOMARINE CORPORATION OF AMERICA R. C. A. COMMUNICATIONS, INC.

RURAL RADIO Report

The Joint Committee on Radio Research* studies ownership and use on farms and villages of less than 2,500 population

BREAKDOWN by STATES

As of January 1st, 1938

69.0% OF ALL U. S. RURAL FAMILIES OWN RADIOS

STATES ARRANGED ACCORDING TO NUMBER OF RURAL RADIO FAMILIES

States arranged according to number of Rural Radio Families	Number of All Families	National Ranking of States	% Rural Families of Total	Number of Rural Families	National Ranking of States	% Rural Families With RADIOS	Rural RADIO Families	National Ranking of States
Pennsylvania	2,452,000	2	31.2	765,000	2	85.0	625,500	1
Ohio	1,777,000	5	31.6	562,000	4	91.0	511,300	3
New York	3,372,000	1	16.8	566,000	3	90.0	509,000	2
Texas	1,516,000	6	56.4	855,000	1	56.0	477,300	4
California	1,818,000	4	24.7	449,000	11	96.0	432,700	5
Illinois	2,063,000	3	26.0	537,000	5	80.0	430,500	6
Michigan	1,920,000	7	39.2	393,000	17	89.0	351,100	7
Indiana	934,000	11	44.1	412,000	13	82.0	336,500	8
Iowa	680,000	17	58.7	399,000	15	79.0	315,300	9
Missouri	1,072,000	10	47.6	510,000	7	58.0	297,200	10
Kentucky	708,000	15	65.8	466,000	9	61.0	286,300	11
Oklahoma	619,000	20	62.4	386,000	19	65.0	251,800	12
Tennessee	689,000	16	62.4	430,000	12	58.0	248,700	13
Minnesota	652,000	19	49.2	321,000	21	77.0	247,600	14
North Carolina	736,000	12	72.0	330,000	6	47.0	246,700	15
West Virginia	417,000	28	68.8	287,000	25	82.0	236,500	16
Wisconsin	735,000	13	45.0	331,000	20	71.0	235,700	17
Virginia	613,000	21	64.6	396,000	16	56.0	221,400	18
Alabama	670,000	18	69.1	463,000	10	48.0	220,600	19
Georgia	716,000	14	65.8	471,000	8	40.0	190,300	20
Washington	468,000	25	42.1	197,000	28	96.0	188,900	21
Kansas	501,000	23	59.3	297,000	23	60.0	178,500	22
New Jersey	1,098,000	9	17.7	194,000	29	91.0	177,100	23
Arkansas	501,000	23	77.4	388,000	18	43.0	166,700	24
Nebraska	352,000	31	63.4	223,000	26	74.0	164,000	25
Mississippi	494,000	24	81.6	403,000	14	35.0	142,400	26
Oregon	599,000	32	47.5	142,000	31	97.0	138,400	27
South Carolina	407,000	30	75.7	308,000	22	45.0	137,800	28
Maryland	410,000	29	38.8	159,000	30	89.0	130,000	29
Louisiana	510,000	22	57.8	295,000	24	44.0	129,300	30
Maine	221,000	34	60.2	133,000	33	91.0	121,400	31
Connecticut	437,000	27	30.0	131,000	34	92.0	120,700	32
Florida	443,000	26	46.3	205,000	27	53.0	108,400	33
Massachusetts	1,104,000	8	10.1	112,000	36	96.0	107,100	34
South Dakota	1,067,000	36	79.6	133,000	33	76.0	101,200	35
Colorado	288,000	33	47.2	136,000	32	70.0	95,300	36
North Dakota	156,000	37	82.1	128,000	35	73.0	93,400	37
Montana	142,000	38	65.5	93,000	37	75.0	70,200	38
Idaho	124,000	40	69.4	86,000	38	75.0	64,500	39
Vermont	99,000	44	66.7	66,000	41	89.0	58,600	40
New Hampshire	136,000	39	43.4	59,000	42	93.0	54,700	41
Utah	123,000	41	44.7	55,000	43	89.0	49,200	42
Arizona	104,000	42	64.4	67,000	40	69.0	46,500	43
New Mexico	102,000	43	73.5	75,000	39	51.0	38,600	44
Wyoming	62,000	46	67.7	42,000	44	75.0	31,700	45
Delaware	67,000	45	49.3	33,000	45	81.0	26,800	46
Nevada	30,000	47	60.0	18,000	46	97.0	17,500	47
Rhode Island	169,000	35	8.3	14,000	47	93.0	13,000	48
Dist. of Columbia	168,000	49	—	—	—	—	—	49
TOTAL U. S.	32,641,000	—	45.0%	13,721,000	—	69.0%	9,470,900	—

** Estimated as of July 1, 1937

* Cost of Survey borne by NBC and CBS.

MAJOR FACTS in a NUTSHELL

	RURAL	URBAN	COMBINED
Total U. S. Families	13,721,000	18,920,000	32,641,000
Total Radio Families	9,470,900	17,195,600	26,666,500
Radio Homes with 2 or more Sets	549,312	3,404,729	3,954,041
Median Number of Years Radio Families have owned Sets	7.0 YEARS	8.2 YEARS	7.7 YEARS
Radio Families Owning an Automobile	7,775,609	11,675,812	19,451,421
Radio Families Owning an Auto-Radio	1,269,101	3,370,338	4,639,438
Radio Families Listening Sometime Daily	8,438,572	13,895,962	22,334,534
AVERAGE WEEKDAY (Monday through Friday)	89.1%	80.4%	83.5%
SATURDAYS	87.8%	76.7%	80.6%
SUNDAYS	86.5%	76.7%	80.1%
AVERAGE 7 DAYS	88.5%	79.8%	82.9%
Median Hours of Daily Use of Radio	4:47 HOURS	4:09 HOURS	4:22 HOURS
BASED ON ALL SETS OWNED			
BASED ON SETS IN USE SOME TIME DURING THE TOTAL DAY	5:18 HOURS	5:12 HOURS	5:14 HOURS

NOTE: In this study, the term "Rural population" conforms to the definition of the U. S. Census Bureau—those living on rural farms or in villages of less than 2500 population. The Census shows several hundred thousand people living on farms in urban areas. These, however, are not classified as "Rural population."

* 100%—ALL RADIO HOMES

The HIGH, MIDDLE and LOW

RURAL RADIO OWNERSHIP FACTORS	ECONOMIC GROUP			U. S. RURAL TOTAL
	HIGH	MIDDLE	LOW	
Percentage of all Rural Families owning home radios	89.0	71.0	47.0	69.0
Percentage of Rural Radio Families with radio set in working order	97.8	96.6	94.4	96.6
Percentage of Rural Radio Families with more than one home radio set	10.5	3.8	1.6	5.8
Number of years average Rural Radio Family has owned a radio	8.3	6.6	5.9	7.0
Percentage of Rural Radio Families owning an automobile	92.3	82.2	65.0	82.1
Percentage of Rural Radio Families with radio-equipped automobiles	92.6	10.0	4.2	13.4

SOUND-MEN themselves frequently are not quite sure just what licenses and permits they must obtain and use for certain phases of their work. As radio dealers and servicemen are becoming interested in sound equipment to a greater extent today than ever before the purpose of this survey is to broadly outline such needs for the benefit of newcomers who wish to be strictly on the safe side.

Starting with equipment, every piece of sound apparatus including microphones, pickups, amplifiers and pre-amplifiers, in my opinion should be inspected before purchasing to see that it bears a seal affixed by the manufacturer as to its licensing and noting under whose patents it is licensed.

The majority of crystal microphones on the market today are licensed under Brush Development Company basic patents on crystal devices, and under the individual manufacturer's own particular design patents.

Amplifiers and pre-amplifiers are generally manufactured under license agreements with the Electrical Research Products, Inc., under patents of the American Telephone and Telegraph Co., and the West-ern Electric Company, Inc.

Amplifiers of your own design or built by you under circuits designed by various transformer, condenser and other companies, if *resold* by you, are in violation of the ERPI patent rights. When an amplifier is made for use by a sound-man himself, this is not a violation because it is not resold for profit.

State and City Merchant Permits

Every radio dealer and serviceman has state and city merchant licenses. Sound dealers should make certain that they have these licenses in their possession. They do not as a rule cost very much and are certainly less than a possible fine if you do not have same when questioned by authorities.

Merchants' licenses are, of course, necessary whether you sell retail or act as a wholesale sales representative for any type of sound equipment.

While sales taxes vary in different states as to their application, it is best to get a written "opinion" from the state and city sales tax

LICENSES *and* PERMITS *for* SOUND *Work*

By ROBERT S. NASH*

WRITES THE AUTHOR: "Since the start of my *Radio Retailing* series about Sound I have received a great many letters asking for information concerning the subject covered in this latest article.

"I have been collecting the material for several months and believe that while my interpretation of requirements is that of a man making his living selling Sound rather than that of an attorney it will at least serve as a practical eye-opener for many in the same game.

"It is not often possible to state definitely without fear of controversy that 'You can do this', or 'You can't do that'. Requirements differ in various parts of the country. And several phases are still in constant litigation.

"While I have here virtually 'shot my bolt' of personal opinion I will be glad to correspond with readers further within the limits of spare time. And I have deliberately included names and addresses of principal licensing organizations to avoid flooding either my own office or those of the Editors with inquiries which might better be filed at these places".

offices, as to their collection from the consumer with respect to sound equipment.

The state and city taxes are in practically every respect charged and collected from the purchaser on all sales of sound equipment. However, charitable institutions, churches, schools, federal, state and city departments are usually exempt from these taxes levied by the state or city.

Sound equipment rentals are not generally taxable. However, an inconsistency in the general status exists in several states as shown by the fact that they charge a sales tax on telephones each month, while they exempt sound rentals because of the "labor and service" angle.

The sales tax officers are generally interested in your inquiries and will give a prompt reply to an inquiry.

Record Production

Perhaps the licenses understood least by the sound specialist are

*NASH COMPANY
5437 Lisette Ave., St. Louis, Mo.

those required for the reproduction of phonograph records and electrical transcriptions over their apparatus.

When a phonograph record or electrical transcription is reproduced over sound equipment, copyrighted material from the standpoint of a registered and copyrighted musical composition, title, music and lyrics is being used.

This licensing is under the jurisdiction of the American Society of Composers, Authors and Publishers, RCA Building, Radio City, New York City, N. Y. John G. Paine is the General Manager. This society consists of practically every known composer of dance and classical selections and has offices in the major cities.

Better known as the "ASCAP", this organization charges a standard license fee to hotels and other establishments of this type for the use of copyrighted musical compositions, while selections over the radio are licensed yearly on the basis of the gross amount received by the particular station for programs.

This organization has been li-
(Continued on page 72)

LOOK FOR *All Three*



1. COMPANY DEPENDABILITY: You must do business with a company whose policies and finances are sound—a company that's progressive, responsible . . . interested in you and your business.

2. PRODUCT DEPENDABILITY: And you must sell the kind of tubes that will win customers' confidence in your ability—enhance your reputation as a reliable retailer.



3. PROFIT DEPENDABILITY: But most important to you, after all, is PROFIT. That's why you must feature a tube line that assures you maximum returns—both on a per-sale basis and from year-to-year, too.

MONEY—hard, cold cash—is your first consideration, of course. But when choosing the tube line to feature, look further than that—check on the company and product as well.

Feature the Sylvania line during 1939. For

Sylvania gives you full measure on “all three”—company, product AND profit dependability. It's the perfect combination for a better tube business . . . this year and every year!

Hygrade Sylvania Corp., Emporium, Pa. • Also makers of Hygrade Lamp Bulbs.

SELL SYLVANIA

SET-TESTED RADIO TUBES

• D E P E N D A B L E A L L W A Y S •



RCA—Record Player VA-20 built to operate with any receiver on plugging into wall socket. Operates up to 30-50 ft. from radio. List \$17.95 fob. Camden.

Preview of New

R C A VICTOR

R C A Manufacturing Co.
Camden, N. J.



COMBINATION — Model U-129 has 10 tube chassis, automatic record changer, extended frequency range, crystal phonograph pickup, constant-speed motor, electric tuning for 8 stations, 12 watts push-pull output, 3-band, straight-line station scale, 12 in. electrodynamic speaker, automatically compensated volume control, continuously variable tone control. List \$185 f.o.b. Camden includes RCA Victor Master Antenna System, membership in Victor Record Society and introductory supply of records.

EMERSON

Emerson Radio and Phonograph Corp.
111 Eighth Ave., New York, N. Y.



EMERSONETTE—A tiny set, 6½ in. wide, 4¾ in. high, 3¼ in. deep as illustrated, designed for auxiliary use such as carrying in luggage, tucking into desk drawers, for book-ends, playrooms, etc. Four in. speaker, illuminated dial in walnut Bakelite, red, green or ivory cabinets. Quantities to be offered to dealers only in proportion to purchases of standard Emerson models. In walnut \$6.95, colors 50c extra.

MAJESTIC

Majestic Radio and Television Corp.
2600 W. 50th St., Chicago, Ill.

MODEL 1A57—Five tube a.c. superhet with tuning range of 538 to 1750 kc. Automatic volume control, full slide rule dial, 5 in. electro dynamic speaker, 6 tuned circuits. Walnut cabinet finished in contrasting woods.

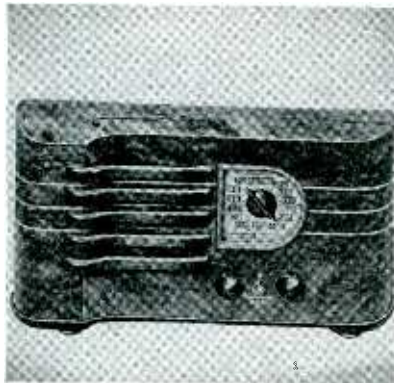
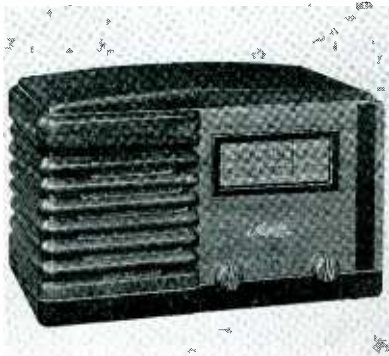

MODEL CH-256—A 5 tube a.c.-d.c. superhet covering standard American broadcasts and police calls Electro-dynamic speaker, "Miracle Tone Chamber", automatic volume control, full-vision dial, beam power tube, built-in antenna. So-called the "Strad" model has an acoustically constructed cabinet, hand-rubbed walnut finish. List \$19.95.



MODEL 259EB—Tuning range of this 5 tube a.c. superhet covers American and foreign broadcasts, police calls, amateur, airplane. Automatic volume control, tone control, 8 tuned circuits, 5 in. electro dynamic speaker, 6 push button permeability tuning, walnut cabinet.

PATHE

Pathe Radio and Television Corp.
2241 Indiana Ave., Chicago, Ill.

REMOTE CONTROL—The Mystic Tuner Wireless remote control operates any radio, gives complete selection, control volume, is compact and light weight requires no attachments to radio, no adjustments on tuner. Equipped with phono-microphone attachments for home broadcasting, etc. List \$19.95.



Radio Merchandise



WEBSTER-CHICAGO—From 5622 Bloomingdale Ave., Chicago come two new model mikes. Crystal model No. 1236 is diaphragm type. Dynamic model 1245 high impedance and Model 1245A low impedance utilize moving coil.

ADMIRAL

Continental Radio and Television Corp.
3800 Cortland St., Chicago, Ill.



MODEL 153-5L—"The Gypsy" is an a.c. superhet portable radio-phonograph combination enclosed in a modern airplane type luggage case. Has large full vision dial, full automatic volume control, 5 in. electro dynamic speaker, covers from 535 to 1730 kc., has Aeroscope self-contained antenna.

MODEL 162-5L—One of a mid-season group of new table models which includes 5 and 6 tube a.c. and a.c.-d.c. sets. Offered in wood or plastics cabinets, the group includes superhets with 4 station push button tuning; a phono combination; features, in some models, the Aeroscope antenna. The superhet a.c.-d.c. set illustrated comes in walnut, ivory, or cream onyx, has automatic volume control, Aeroscope antenna, 5 in. electro dynamic speaker, covers from 535 to 1730 kc.

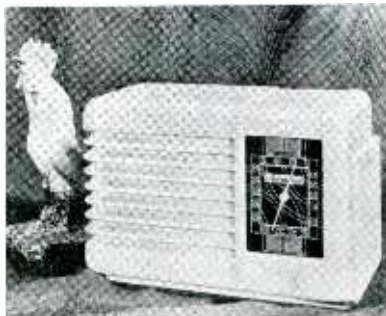

PHILCO

Philco Radio and Television Corp.
Philadelphia, Pa.



MODEL 31XK—Six tube superhet with electric push button tuning to eight stations. Dial in streamline type mounted on inclined control panel. Balanced field cathedral speaker, bass compensation, 3 point tone control. Cabinet of sliced walnut with butt walnut contrasts.



RECORD PLAYER—Console wireless record player automatically accommodates 8 records for continuous playing and allows for a record library in the base of the cabinet. The hinged lid gives a distinct furniture appearance. Operates anywhere within 60 feet of the radio. Also recently announced is a portable model wireless record player.

PACENT

Pacent Engineering Corporation
79 Madison Ave., New York, N. Y.



RECEIVER KIT—High fidelity receiver, "Pacent Celebration," available in kit form or completely wired. Features extremely high fidelity tone quality, flexibility of assembly and ease of operation. May be assembled so that speaker, tuner and audio system can be located at different points and remotely operated. Cabinets in knock-down form, list \$125.

STEWART-WARNER

Stewart Warner Corp.
1826 Diversey Parkway, Chicago, Ill.

MODEL 07-511 to 07-513—Five tube superhet operating on either 110 volt a.c. or d.c. Five tuned circuits. Covers standard broadcast and one police band, resistance coupled beam power audio system, automatic volume control, built-in antenna, magic dial with illuminated tip pointer. Available in walnut Bakelite, Ivory Plaskon, or solid color cabinets. School letters or personalized initials available.

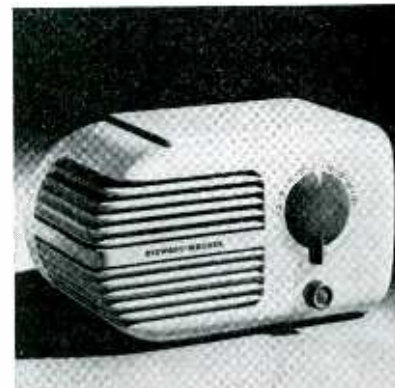

NO AERIAL! NO GROUND!

WITH THE

NEW

Aeroscope

ANOTHER

Admiral

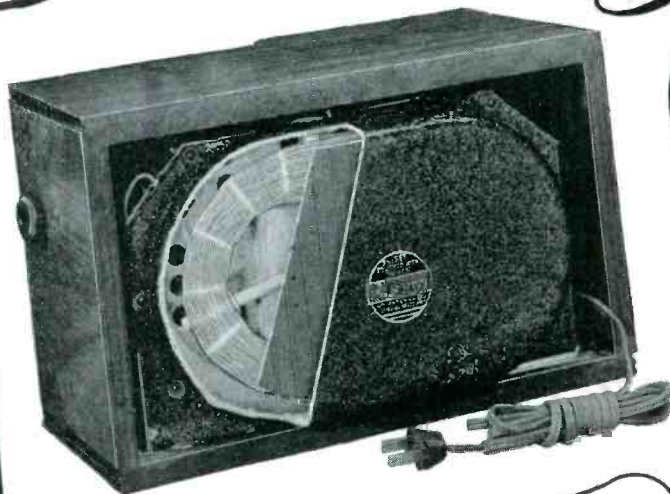

1ST

AT THESE
SENSATIONALLY
LOW PRICES

Think of it! A completely built-in aerial and ground in a line of radios that sell for as low as \$9.95. And that's not all! In the series 5D and 6K, the Aeroscope introduces a unique interference shield that effectively reduces static and other noise. Nothing like it ever before!

Only Admiral could do it!

THIRTEEN new radios . . . a baker's dozen of money-makers for the winter and spring months. Features galore! Aeroscope . . . the built-in aerial and ground with unique interference shield . . . is only one of them! Colorful plastic cabinets . . . automatic tuning . . . portable battery radios and phono combinations styled like modern aeroplane luggage. You'll find them all in our new circular opposite. Keep it for future reference . . . or ask your jobber for a supply for distribution to your customers.

See

**SPECIAL
CIRCULAR
FOR NEW**

Admiral

**MONEY
MAKERS**

CONTINENTAL RADIO & TELEVISION CORP.

3800 WEST CORTLAND STREET • CHICAGO, ILLINOIS

NO AERIAL! NO GROUND!
WITH THE NEW

Admiral * Aeroscope

Model 151-5L
Walnut Plaskon Cabinet

\$9.95

162-5L Ivory \$12.95
162-5L Onyx \$15.95



162-5L A



161-5L >

ADMIRAL "SMART SET" 6-TUBE (INCLUDING BALLAST) AC-DC SUPERHET

We call it the Admiral "Smart-Set"—a fitting name for its smartly styled molded plaskon cabinet of cream onyx, cream ivory or rich walnut. Tunes complete broadcast band (535 to 1730 K.C.). Exceptional tone quality of super electro dynamic speaker enhanced by louvre type tone chamber. Complete with built-in Admiral Aeroscope! No aerial or ground required.

ADMIRAL RADIO PHONOGRAPH COMBINATIONS →

Admiral sounds a new note in radio phonograph combinations. A 6-Tube radio (including ballast) tunes complete broadcast band (535 to 1730 K.C.). Delightful tone quality of super electro dynamic speaker enhanced by louvre type tone chamber. Complete with built-in Admiral Aeroscope. No aerial or ground needed! Phonograph has new light weight crystal pick-up with quiet self-starting electric motor. Plays 10" and 12" records. For AC operation only.

Model 153-5L. Admiral "Gypsy". Completely portable in modern airplane luggage case with convenient pocket for records. (As Shown) **\$36.95**

Model 159-5L. Straight grain walnut cabinet with piano finish (Not Shown) **\$32.95**



153-5L

IN CABINETS OF
 MODERN PLASKON
 Model 166-5D (walnut) \$16.95
 Model 167-5D (ivory) \$19.95
 Model 168-5D (onyx) \$22.95

Model 169-5D. Beautiful straight grain and butt walnut wood cabinet \$24.95
 Aeroscope. No aerial or ground required.
 Tunes entire broadcast band (535 to 1730 K.C.). Complete with built-in Admiral
 stations . . . full automatic volume control . . . specially designed tuning con-
 denser . . . super electro dynamic speaker . . . attractive etched glass dial.
 What a radio! Has "feather touch" automatic push-button tuning for four

ADMIRAL "STREAMLINER" AC-DC
 6-TUBE (INCLUDING BALLAST) SUPERHET



... assures full volume and power.
 itself . . . picks up distant signals with ease
 . . . completely within the radio set
 ground wires. Admiral's new "Aeroscope"
 bye to troublesome aeriels and unsightly
 Say good-



Another Ad-
 miral first at
 these sensa-
 tional prices!

Admiral

NO AERIAL! NO GROUND!
 WITH THE NEW



PORTABLE BATTERY RADIO
 Model 164-4D. Modern airplane luggage case. 4-tube, 1½ volt superhet battery radio has 5" permanent magnet type speaker. Tuning range 535 to 1730 K.C. Complete with built-in Aeroscope. No aerial or ground required . . . \$24.95



ADMIRAL 6-TUBE AC SUPERHET
 In Beautiful Walnut Cabinet

Model 148-6K. Has all the latest features! Feather touch automatic push-button tuning for four stations . . . unique ribbed wheel type station selector and on-off switch with volume control instead of conventional tuning knobs . . . super electro dynamic speaker . . . attractive slide rule etched glass dial . . . full automatic volume control. Tunes entire broadcast band from 535 to 1730 K.C. Complete with built-in Admiral Aeroscope. No aerial or ground required . . . \$27.95



5-TUBE AC-DC SUPERHET
 5 full-working tubes! Tunes entire broadcast band (535 to 1730 K.C.). Has full vision dial, vernier tuning, 4" electro dynamic speaker, automatic volume control. In compact, smartly styled plastic cabinets.
 156-5J (walnut) . \$9.95 157-5J (ivory) . \$12.95
 158-5J (onyx) . \$14.95

NO AERIAL! NO GROUND!
 WITH THE NEW

Aeroscope

ANOTHER
Admiral
 FIRST
 AT SENSATIONALLY LOW PRICES

CONTINENTAL RADIO & TELEVISION CORP.
 3800 W. CORTLAND ST. CHICAGO, ILL.

PREVIEW OF NEW RADIO MERCHANDISE

THORDARSON

Thordarson Electric Mfg. Co.
500 W. Huron St., Chicago, Ill.

TRANSFORMER — Tropex transformer is a unit additionally protected by covering of a special transparent and elastic compound which is highly resistant to salt air, high humidity, excessive moisture and other weather conditions which tend to shorten transformer life. Cost is moderate being increased from 20c to 50c list over and above cost for unprotected type.

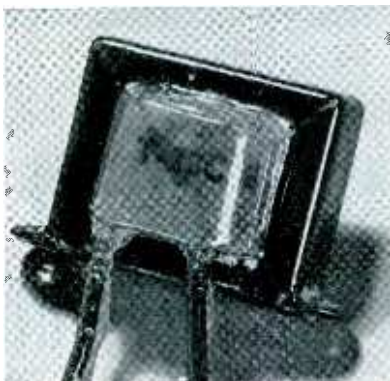

UTAH

Utah Radio Products Co.
812 Orleans St., Chicago, Ill.

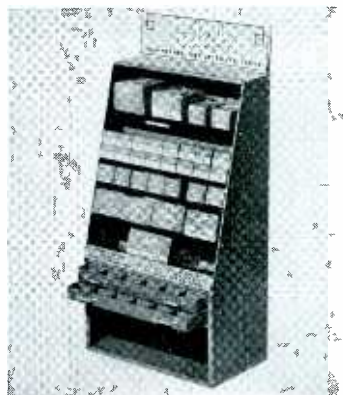

SERVICE-PAK — Survey of current radio servicing practices and procedures dictated the items included in the assortment of 79 basic replacement parts which are included in an attractive all-steel cabinet. The cabinet is actually a miniature store room and facilitates keeping of perpetual inventory. Dealer price is \$29.95.

STAR

Star Machine Manufacturers, Inc.
1377 East Bay Ave., Bronx, N. Y.



SHAFT TOOL—Auto radio flexible shaft tool removes old fittings, swedges cables, fastens new fittings to cable, easy to operate, especially suited for small dealer. Net dealer price \$7.50.

CROWE

Crowe Name Plate and Manufacturing Co.
3701 Ravenswood Ave., Chicago, Ill.

PANEL MOUNTING KITS —For auto radios are variously styled to suit control boards of different makes of automobiles. No. A 17030, illustrated, is styled to suit the Chevrolet. The interchangeable feature of Crowe controls is said to permit the transfer of practically any radio from car to car, simply by using the appropriate panel kit.

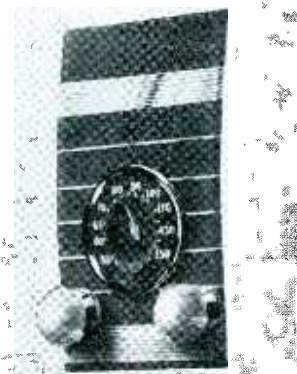

A T R

American Television and Radio Co.
300 E. Fourth St., St. Paul, Minn.

VIBRATORS—Feature oversized $\frac{3}{8}$ in. diameter tungsten contacts having full-wiping action, perforated reed of Swedish spring steel, efficient magnetic circuit with formed base, flexible leads with tinned clamp supports.



PHILCO

Philco Radio and Television Corp.
Philadelphia, Pa.



AIR CONDITIONER—One of three new models included in the line of portable air conditioning units known as York-Cool Wave. The $\frac{1}{4}$ h.p. (shown) is for bedroom use, the $\frac{1}{2}$ h.p. is for office use, and the $\frac{3}{4}$ h.p. is for large living rooms. The company also makes a $1\frac{1}{2}$ h.p. console unit. Price range for the portable models is about that of a good radio, control is simple, electricity cost is low.

SELECTONE

Selectone Mfg. Co.
108 S. Calvert St., Baltimore, Md.



CONTROL CABINET—Main control cabinet for housing amplifiers which takes standard width panels and may be obtained in dark brown, gray green, slate grey, deep cream, light cream, black.

REFRIGERATOR — Conservador—one of 8 new models which make up the new complete line of electric refrigerators with which Philco is entering the refrigerator field through its subsidiary Philco Refrigerator Company. The new Conservador inner door allows 26% more quickly usable space than previously, and increases conveniences of use.



HOW DO YOU FEEL ABO



IT HAS NO PLACE IN THE LEONARD WAY OF DOING BUSINESS

Leonard "puts on the pressure" where it counts . . . on products and policies that create no cut-throat competition and destructive practices. That's why Leonard dealers stay in business and keep on making money.



SURE—high-pressure selling methods get "results!"

Orders come pouring in . . . sales curves go zooming up . . . everybody, from the salesmanager down to the delivery boy, gets excited.

It's a great party until the "shot in the arm" wears off. Then, it's tough.

For, sure as shooting, there's only one thing the "high-pressured" dealer can do—get out from under, by any method that presents itself . . . price-slashing, cut-throat competition. Then, both he and other dealers suffer.

★ ★ ★

Leonard distributors don't use "high-pressure selling." They make money without it, and so do Leonard dealers.

Leonard distributors believe in letting the dealer set the pace . . . *help* him grow, instead of forcing him.

Dealers *aren't* tacks on maps, but business men with a right to their independence.

Above all, Leonard gives every dealer territory to *grow into*.

Naturally, the Leonard Way of Doing Business has attracted distributors who are sound and amply financed . . . men who long ago learned that their growth depends upon the growth of their dealers.

They like this fair and square and *steady* way of doing business. They appreciate that it means reducing dealer mortality, and increasing sales from their outlets.

If this kind of a slate sounds good to you, look up the Leonard distributor nearest you and check this advertisement with a lot of personal experiences—dealer experiences.

And for proof of where Leonard *does* put the pressure—see the great Leonard line for 1939! At least, why not find out? LEONARD, 14250 Plymouth Road, Detroit, Michigan.

YOU BUY AS YOU SELL
IN THE

LEONARD WAY

UT "HIGH PRESSURE"?

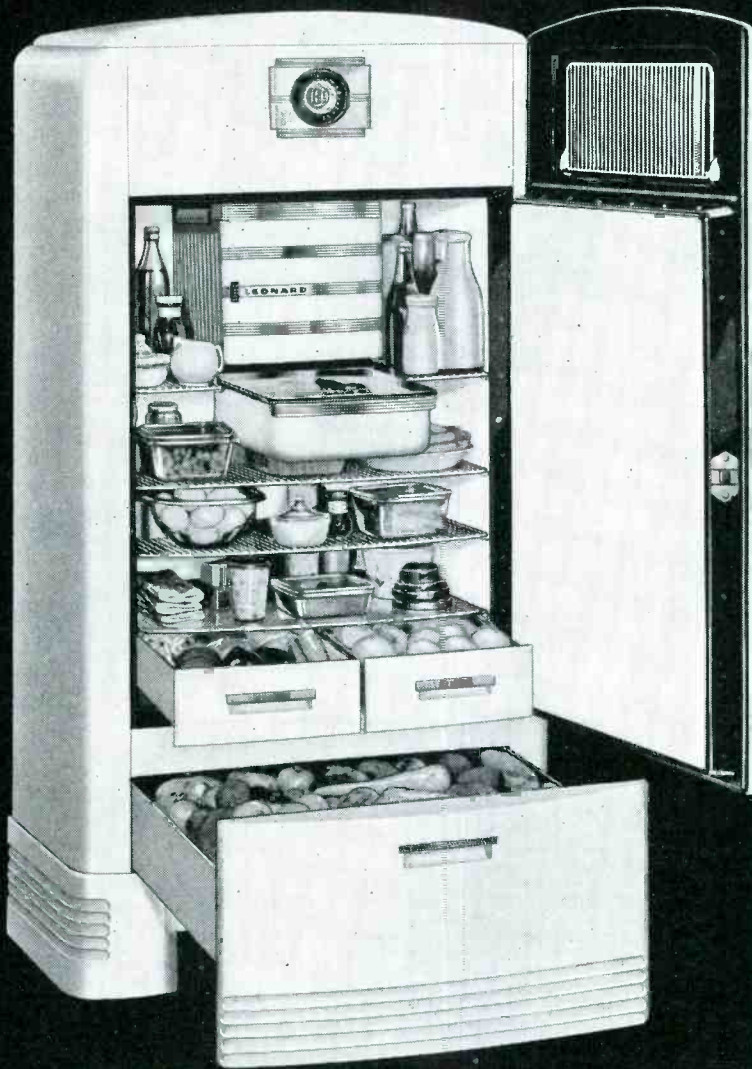

Leonard Travels in Good Company

SEE IF YOU DON'T AGREE ABOUT LEONARD VALUES

Sum up all the points. The Glacier sealed unit, with a record for low-cost trouble-proof service that is, we believe, without parallel in the industry.

New Zero-Freezer—of stainless steel—which helps freeze cubes faster and also provides storage space for "fast-frozen" foods.

All trays in standard models furnished with time-saving "Ice-Popper" Cube Release.

The Master Dial with built in ther-

mostat, gives customer absolute control over temperature . . . assures perfect service in hot weather . . . cuts down electricity costs.

Extra-capacity dry storage vegetable bin which holds nearly two bushels.

The glass-covered "Meat File," and "Show-case Food File," for perfect food conditioning.

New 3-way Len-A-Latch.

. . . and a "supporting cast" of many other novel and salable features.

Albany, N. Y.	E. S. & E. Co., Inc.
Altoona, Pa.	Electric Appliance Distributors
Amarillo, Tex.	Nunn Electric Co.
Atlanta, Ga.	Lamar-Rankin Co.
Binghamton, N. Y.	Morris Distributing Co.
Birmingham, Ala.	Magic City Appliance Co.
Boise, Idaho	Bertram Motor Supply Co.
Boston, Mass.	J. H. Burke Co.
Buffalo, N. Y.	Joseph Strauss Co.
Charleston, W. Va.	Eskew, Smith & Cannon
Charlotte, N. C.	Page-Williamson, Inc.
Chicago, Ill.	L. C. Wiswell Co.
Cincinnati, Ohio	Schuster Electric Co.
Cleveland, Ohio	Arnold Wholesale Corp.
Columbus, Ohio	Appliance Distributing Co.
Dallas, Texas	Peaslee-Gaulbert Corp.
Dayton, Ohio	York Supply Co.
Decatur, Ill.	Linn & Scruggs
Denver, Colo.	Hendrie & Bolthoff Co.
Des Moines, Iowa	A. A. Schneiderhahn Co.
Detroit, Mich.	Buhl Sons Co.
Dodge City, Kans.	Mullin Furniture Co.
Escanaba, Mich.	Delta Hardware Co.
Grand Rapids, Mich.	J. A. White Distributing Co.
Harrisburg, Pa.	Knerr, Inc.
Indianapolis, Ind.	United Distributing Co.
Kansas City, Mo.	Federal Distributing Co.
Knoxville, Tenn.	Maytag Appliance Co.
Los Angeles, Cal.	Graybar Electric Co.
Louisville, Ky.	Stratton-Terstegge Co.
Memphis, Tenn.	Harry T. Wilson Co.
Miami, Florida	Major Appliances, Inc.
Milwaukee, Wisc.	Taylor Electric Co.
Minneapolis, Minn.	Enger Supply Co.
Montgomery, Ala.	Mathews Furniture Co.
Nashville, Tenn.	McWhorter, Weaver Co.
Newark, N. J.	E. B. Latham Co.
Newburgh, N. Y.	Shapiro Sporting Goods Co.
New Haven, Conn.	H. M. Tower Corp.
New Orleans, La.	Radio Specialty Corp.
New York, N. Y.	E. B. Latham Co.
Omaha, Nebr.	Paramount Radio Shop, Inc.
Paducah, Ky.	Gleaves & Son
Peoria, Ill.	Cohen Furniture Co.
Philadelphia, Pa.	Motor Parts Co.
Phoenix, Ariz.	Graybar Electric Co.
Pittsburgh, Pa.	J. A. Williams Co.
Plattsburgh, N. Y.	A. H. Marshall Co.
Portland, Maine	Cressey & Allen
Portland, Ore.	Electrical Distributing, Inc.
Providence, R. I.	Ballou, Johnson & Nichols Co.
Richmond, Va.	Graybar Electric Co.
St. Louis, Mo.	Electric Lamp & Supply Co.
Salt Lake City, Utah	United Electric Supply Co.
San Francisco, Cal.	Graybar Electric Co.
Seranton, Pa.	Household Appliance Distributors
Seattle, Wash.	Seattle Hardware Co.
South Bend, Ind.	Cloud Bros.
Syracuse, N. Y.	Morris Distributing Co.
Toledo, Ohio	Electric Range & Equip. Co.
Trenton, N. J.	Adams Distributing Co.
Tulsa, Okla.	Otasco Supply Co.
Washington, D. C.	Southern Wholesalers, Inc.
Wichita, Kans.	McKelvey's
Williamson, W. Va.	Persinger Supply Co.

of Doing Business

PREVIEW OF NEW RADIO MERCHANDISE

CROSLEY

The Crosley Corporation
Cincinnati, Ohio

READO—Facsimile receiver is sold at a popular price for demonstration and experimental use where printed news and similar information is desired. Apparatus is available so that receiver can be turned on automatically at a predetermined time, the printing done, and the equipment turned off. Transmission and reception is at the rate of about three feet of printed paper per hour. Price of printer model 118 is \$79.50, price of radio used in connection with it is \$60.00.



ANDREA

Andrea Radio Corporation
48-02 48th Ave., Woodside, N. Y.

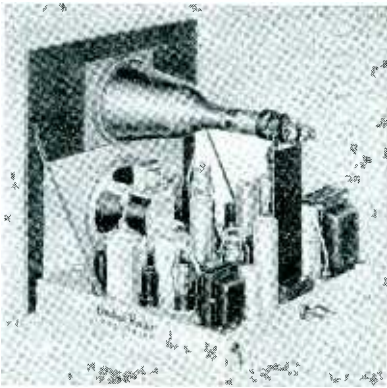

TELEVISION KIT — "Sharp Focus" KT-E-5 is a carefully designed construction kit for receiving sight and sound supplied in knocked-down form with detailed instructions. Employs short-neck cathode ray picture tube. Five in. picture tube; cadmium plated steel chassis, six controls—tone, volume, power, picture brilliance, focus, station selector, contrast.

OHMITE

Ohmite Manufacturing Co.
4835 Flourney St., Chicago, Ill.

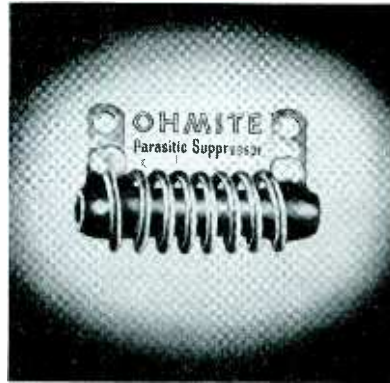

PARASITIC SUPPRESSOR—Type P300 is designed to prevent ultra-high frequency parasitic oscillations which occur in plate and grid leads of parallel or push-pull tube circuits. Suppressor is inserted in grid lead at tube socket. Introduces negligible resistance at fundamental frequency and does not affect driving power needed. Non-inductive vitreous-enameled resistor combined with a choke into one integral unit in compact form.

CONSOLIDATED

Consolidated Wire & Associated Corporations
514 S. Peoria St., Chicago, Ill.

RESISTORS—A line of carbon fixed resistors of solid, molded construction—permanently bonded into one compact unit. Tolerance or resistance variation is claimed to be maintained at 5% average. Quiet in operation, completely moisture-proof and non-inductive, having no capacity effect. Maintain resistance values over wide temperature range. For use in any r.f. or audio circuit.



SPRAGUE

Sprague Products Co.
North Adams, Mass.

CONDENSERS—Type HLV low voltage high capacity dry electrolytic condensers in round aluminum cans for use with "A" eliminators, moving picture sound equipment and similar circuits. Seven units ranging from 500 mfd. at 12 volts to 2,000 mfd. at 25 volts. Priced from \$2.38 for 500 mfd. capacity to \$12.44 for 2,000 mfd. capacity.



OPERADIO

Operadio Manufacturing Co.
St. Charles, Ill.

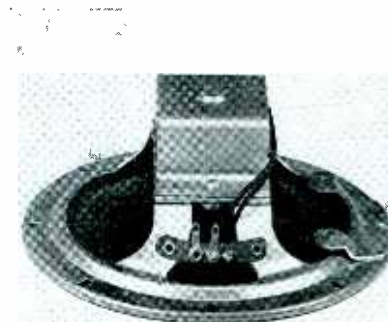

REPLACEMENT SPEAKERS and Uni-Match Transformers give maximum service with any impedance that may be required. Speakers are of direct-voice coil type. Uni-Match transformer is mounted on speaker by self-tapping screws, speaker is matched to any desired impedance by adjustment of Rotary Switch on terminal strip leads are connected and the speaker is ready to go. Rotary Switch makes easily available low, medium, and high impedance.

DUMONT ELEC.

Dumont Electric Company
514 Broadway, New York, N. Y.

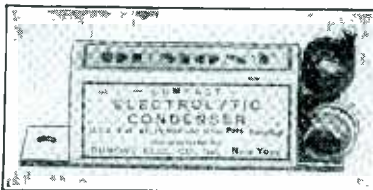

ELECTROLYTIC CONDENSER — Available in either single or dual units, ratings on the recently announced condensers are as follows: Peak voltage, 600; working voltage, 450; capacity, 8 mike; 8 mike dual; size single unit, 3/4 in. high, 1 in. wide, 2 in. long; size dual unit, 3/4 in. high, 1 1/2 in. wide, 2 in. long.

AMPHENOL

American Phenolic Corp.
1250 Van Buren St., Chicago, Ill.

LOCTAL SOCKETS—Available in black bakelite or tan ultra-low-loss mica filled bakelite. Supplied with molded-in-plate, retainer ring mounting or an adapter plate for replacement work. Contacts have long wiping action and grip the entire length of tube prong securely.



PREVIEW OF NEW RADIO MERCHANDISE

TRIUMPH

Triumph Mfg. Co.
4017 West Lake St., Chicago, Ill.

TESTER—Model 430-LX push button loctal tube tester with a spare loctal socket for roaming filaments, and facilities for testing 7 and 35 volt tubes. Tests all electronic types of tubes for dynamic electronic conductance, has a socket for pilot light tests. Push buttons set up test circuit, neon short indicator shows continuity in ballast units. Portable or counter models. List \$29.95.



SOUNDMASTER

John Meck Instruments
164 N. May St., Chicago, Ill.

SOUND LEVEL METER—Pattern 15 portable acoustic sound level meter is calibrated to read in decibels of sound level (range plus 50 to 130 db.). Operates entirely from self-contained batteries and has microphone free from directional characteristics. Uses include analysis of coverage provided by a sound installation, measurement of the sound level produced by a public address system or audience to be covered, comparison of speaker efficiencies. Dealer price \$60.00 complete with tubes and batteries.



SIMPSON

Simpson Electric Co.
5216 W. Kinzie St., Chicago, Ill.



TESTER—"Hammeter" set tester, a self-contained pocket-size portable instrument built to check high voltage and all component parts of transmitters and receivers. A 3,000 volt, self-contained unit accurate within 2% on d.c., 5% on a.c. Tests a.c. voltage and ohmmeter ranges. Bakelite case and test cables insulated for 5,000 volts, insulated tips.

SUPREME

Supreme Instruments Corp.
Greenwood, Miss.

TESTER—Model 503 tube tester incorporates loctal socket and obsolescence proof push button type, filament return selector system. Any filament termination combination available. Employs rotary two color chart to indicate tube type setting. Quality tests made at proper load for highest accuracy. Separate test voltages and loads used for various classes of tubes. Employs 4 in. 1 milli-ampere movement with long scale, dead beat pointer, forged magnet, jewel bearings. List \$39.50.

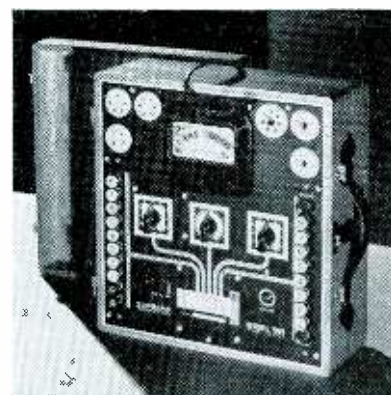

SPEAK-O-PHONE

Speak-O-Phone Recording and Equipment Co.
23 W. 60th St., New York, N. Y.

RECORDER—For instantaneous recording in schools, homes, commercial uses, etc., handles speech or music on aluminum or acetate with slight adjustment. Mounted in carrying case, has outer rim drive, adjustable tension, constant speed at 78 rpm. for recording from outside in. Tracking mechanism concealed, high fidelity mike, diamond and steel cutting needles. List \$150.00.



ELECTRO PRODUCTS

Electro Products Laboratories
549 W. Randolph St., Chicago, Ill.

BATTERY ELIMINATOR—Operating on any 6-volt storage battery, wind charger, or other power source, Model J "A" and "B" battery eliminator is specially built for use with farm radio and low power transmitters. Provides 1 1/2 or 2 volt "A" power and "B" voltages of 45, 67, 90, 135 and 180 volts at 40 milliamperes. Will supply requirements of average 7-tube radio approximately 50 hours on one charge of 130 ampere hour storage battery. List \$19.95.



DAGO

Dayton Acme Company
1100 Sycamore St., Cincinnati, Ohio



TUBE TESTERS—Seamless cabinet with built-in roller chart assembly for tube tester featuring locking type push button circuit selector, "hot" shorts and leakage test. Tests new series of 1.4 volt battery tubes, 2 volt battery tubes at end point of "A" battery life, OZ4's, loctal type tubes. Tests both plates separately on cathode type as well as filament type rectifier tubes, dial light bulbs, ballast units. To dealer \$37.95.

BOGEN

The David Bogen Co., Inc.
663 Broadway, New York, N. Y.

AMPLIFIER—Model DX-18 is a new 10 tube 18 watt amplifier, features electronic tone corrector to correct and make allowances for varying room acoustics. Has two high and two low gain inputs. Comes complete with 10 tubes. Remote control optional.



Only RCA Makes
and Does Everything
in Radio and
Sound

IT PAYS TO GO

RCA All the Way!

Because public
acceptance
means bigger
profits

RCA Victor

THE STANDOUT LINE FOR '39!

This year—sell RCA Victor for volume! The two fine instruments illustrated here typify the sort of splendid values you can offer! Remember—these new RCA Victors enable you to offer stand-out styling...standout performance...standout prices...standout features! That's why this year more than ever, it will pay you to push RCA Victor!



(Below) RCA Victor Model 96T4 offers you many stand-out sales features including Electric Tuning, Domestic and Foreign Reception, Police Calls, 2-band Clear Vision Illuminated Dial, 6 RCA Victor Tubes, Magnetite Frequency-Locking Transformers and Automatic Volume Control. Works on both AC and DC. Has handsome ultra-continental style cabinet in dark, hand-rubbed lacquer finish. **\$29⁹⁵***

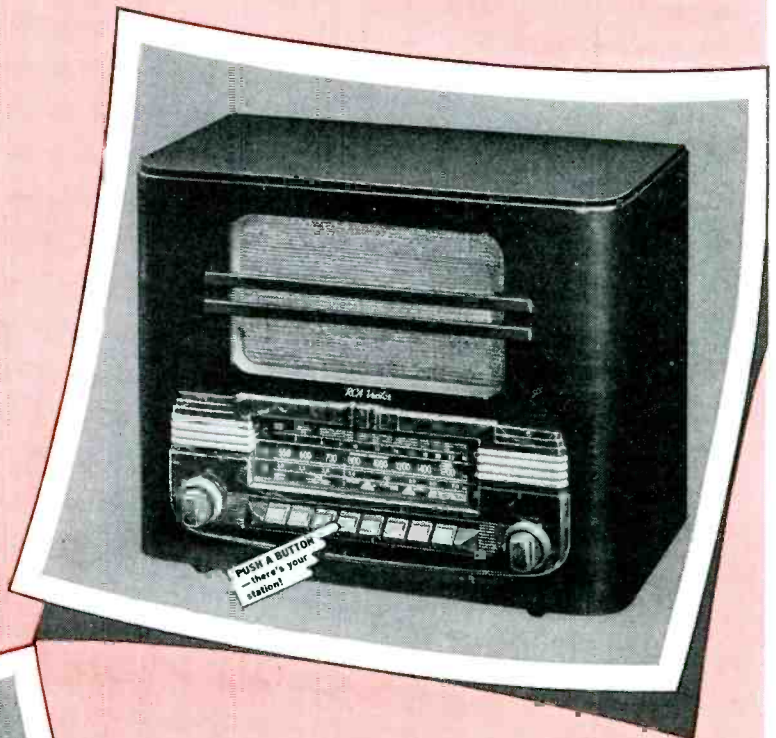

(Above) NEVER BEFORE... A 3-BAND SUPER-SIGHT DIAL RADIO AT SUCH LOW COST! This stand-out value also offers Electric Tuning, RCA Victor Tubes, Victrola Button, Domestic and Short Wave Reception, Amateur Calls, Magnetite Frequency-Locking Transformers, and many other stand-out features that will mean big business for you! Has new ultra-continental style cabinet in dark, hand-rubbed **\$39⁹⁵*** lacquer finish. It's Model 96T7.



*All prices f.o.b. Camden, N. J. subject to change without notice. *Listed to the Magic Key every Sunday, 2 to 3 P. M., E. S. T., on the NBC Blue Network.*

For finer radio performance... RCA Victor Radio Tubes

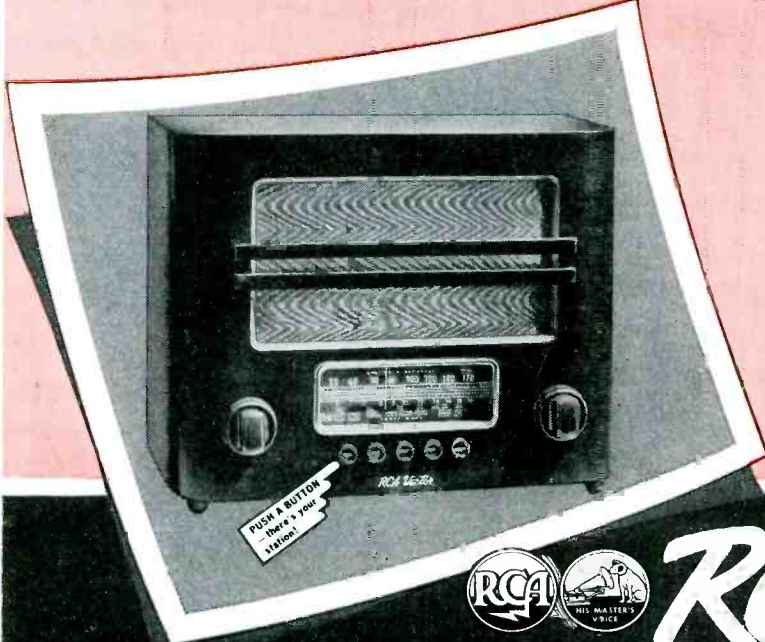

RCA Victor

RCA Manufacturing Co., Inc., Camden, N. J. A Service of the Radio Corporation of America

Only RCA Makes
and Does Every-
thing in Radio
and Sound

IT PAYS TO GO
RCA All the Way!

Only RCA offers
the Public Accep-
tance that means
bigger profits for you

Now everybody can listen with
THE LITTLE RADIO
WITH THE BIG NAME!

...at the lowest price in RCA Victor history!



5 Beautiful, New,
Brilliantly Colored
Models...

Illustrated is Little
Nipper Model 9TX1,
molded plastic cabi-
net, walnut finish,
tan knobs, \$9.95*.
Other models in a
variety of colors at
\$12.95*, \$14.95*,
and \$17.95*.

RCA Victor
LITTLE NIPPER

\$9.95*

**STANDOUT SALES
FEATURES**

- 1 Powerful Superhetero-
dyne Circuit
- 2 Five RCA Victor Tubes
(two double purpose,
providing better perfor-
mance than many 7-tube
radios)
- 3 Electro-dynamic Speak-
er
- 4 AC-DC Operation
- 5 Built-in Antenna
- 6 Automatic Volume Con-
trol

The desire for a little radio is sweep-
ing the country! People want a *good*
little radio—that's why it will pay
you to sell RCA Victor Little Nip-
pers—the little radio with the big
name—offering outstanding per-
formance—atamazingly low cost!

*Prices f.o.b. Camden, subject to change
without notice. For finer radio per-
formance—RCA Victor Radio Tubes.

RCA Victor

RCA Manufacturing Co., Inc., Camden, N. J.
A Service of the Radio Corporation of America



"It Sells
tubes for me"

says a service man about

**NEW RCA
TUBE TESTER!**



COSTS ONLY
\$37.95
NET
Stock No. 156-A

Counter type RCA Tube
Tester, Stock No. 156-A,
net price, \$37.95. Also
available in carrying case
for portable use as Stock
No. 156—net price, \$39.95

This great new RCA Tube Tester
helps you sell tubes! Proof of this is
seen in the statements made by a
service man in a recent letter to us:

"As one of the first to receive a new RCA
Tube Tester I have noticed a very substan-
tial increase in my tube sales... without
the usual sales talk. Every customer is
personally interested in the true condition
of his radio tubes and since the average
radio owner can easily understand the ac-
tion of the RCA Tube Tester, he is entirely
convinced that his tube is either bad or
good, as the case may be. Actually he sells
himself new tubes."

Amazingly simple to work, the new
RCA Tube Tester offers a score of out-
standing features at low cost. Full details
from your RCA parts distributor.

RCA Test Equipment

RCA Manufacturing Co., Inc., Camden, N. J.
A Service of the Radio Corporation of America

Only RCA Makes
and Does Everything
in Radio and
Sound

IT PAYS TO GO

RCA All the Way!

Only RCA offers the
Public Acceptance
that means bigger
profits for you

RCA Victrolas...and Victor and Bluebird Records — **The Fastest Growing Field for Your Sales Activities**

Stock Victor and Bluebird Records for Fastest Turn-over!

National sales increases in RCA Victrolas, Victor and Bluebird Records are among the most sensational in the entire merchandising world... but it's only the beginning! Here's one field that has only been scratched... that offers all the room in the world for expanding sales! The rapidly growing vogue for Victor Record music throughout the country is putting millions of people in the market for record playing instruments and records. Learn all you can about this field from your RCA Victor distributor.

VICTOR RECORD SOCIETY OFFER

\$25.95 Value—in RCA Victrola Attachment and Victor or Bluebird Records—for \$14.95!†



More than 100,000 people have already taken advantage of this offer. Offer provides \$14.95 (list price) RCA Victrola Attachment, \$9.00 in Victor or Bluebird Records customer chooses, \$2.00 subscription to Victor Record Review, and Victor Record Society membership. RCA Victrola Attachment can be connected to any modern AC radio at little or no expense; plays Victor and Bluebird Records with full tone of set.

† This offer subject to change without notice.

Everything music lovers want is in this RCA Victrola U-134A — Price includes \$9 worth of Victor or Bluebird Records!

Combines Victor Record and radio entertainment. Has new Gentle Action Automatic Record Changer, Feather-touch Crystal Pick-up with top-loading Needle Socket... 16-tube Radio has Electric Tuning for 8 stations. Price includes \$9.00 worth of any Victor or Bluebird Records, \$2.00 subscription to Victor Record Review, Victor Record Society membership, and RCA Victor Master Antenna. In Mahogany, \$365.00*. Walnut . . . \$355.00*



RCA VICTROLA U-112

An outstanding value, that combines Victor Record and radio entertainment. This handsome table model has Feather-touch Crystal Pick-up, and a powerful superheterodyne radio. Price includes \$4.50 worth of any Victor or Bluebird Records customer chooses, \$2.00 subscription to Victor Record Review, and Victor Record Society membership, \$39.95*.

*Prices f.o.b. Camden, N. J., subject to change without notice.

Listen to the "Magic Key of RCA" every Sunday, 2 to 3 P. M., E.S.T., on the NBC Blue Network.
FOR FINER RADIO PERFORMANCE—RCA VICTOR RADIO TUBES



RCA Victrola

A SERVICE OF THE
RADIO CORPORATION
OF AMERICA

COMBINES RECORD AND RADIO ENTERTAINMENT

Only RCA Makes
and Does Everything
in Radio and
Sound

IT PAYS TO GO

RCA All the Way!

Only RCA offers the
Public Acceptance
that means bigger
profits for you

TOPS!

*...in Quality
...in Performance*



It pays to sell a product that insures high quality and fine performance. Because then you need not worry about expensive call-backs or dissatisfied customers.

Get behind RCA Radio Tubes — take advantage of the excellent quality built into these tubes by the world's most famous tube engineers — take advantage of the fine promotional helps and advertising that RCA offers. You will make more money.

Listen to the Magic Key of RCA every Sunday, 2 to 3 P. M., E. S. T., on NBC Blue Network.

Over 325 million RCA Radio Tubes have been purchased by radio users. In tubes, as in radio sets, it pays to go RCA All the Way.



Radio Tubes

RCA MANUFACTURING CO., INC., CAMDEN, N. J.
A SERVICE OF THE RADIO CORPORATION OF AMERICA



can you match this man?

John Doe has a reputable radio service business.

Have you?

His location is free from interference with already established Tung-Sol agents.

Is yours?

He has the necessary background and equipment to service radio.

Check?

He turns over his tube stock at least every three or four months.

How about you?

His facilities lend themselves to prominent display of attractive advertising material.

Do yours?

He has a reputation for maintaining standard prices.

What about yourself?

He could render prompt monthly reports of consigned stock with remittance for tubes already sold.

Would you?

IF YOU CAN MATCH HIM . . . there's the "greatest" deal in radio waiting for you. Write for details.



TUNG-SOL LAMP WORKS Inc., Dept. B Radio Tube Division

SALES OFFICES: Atlanta • Chicago • Dallas • Denver • Detroit • Kansas City
Los Angeles • New York • General Offices: Newark, New Jersey

PREVIEW OF NEW RADIO MERCHANDISE

EICOR

Eicor, Inc.
515 S. Laflin St., Chicago, Ill.

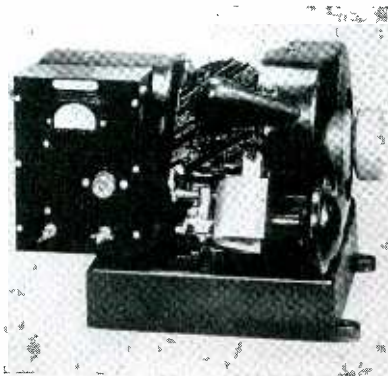

ELECTRIC LIGHT PLANT
—Type 3AP6 will light 12 25-watt lamps or operate a standard a.c. radio and 8 lamps. Also can be used to charge 6-volt storage batteries. Engine is 4-cycle, single cylinder, air-cooled 5/8 h.p., with constant speed maintained by fly-ball type governor. High tension magneto ignition, push button starter.

UNIVERSAL

Universal Camera Corp.
32 W. 23rd St., New York, N. Y.

PROJECTOR—Five hundred watt 8 mm. projector gives brilliant pictures up to 5 by 7 ft. with still picture projection possible. The lens is f 1.6 one in. focus, condensing lens, die-cast frame construction, forced draft cooling, prefocused lamp socket, variable speed control, heavy duty universal motor operating on 105 to 120 volts.

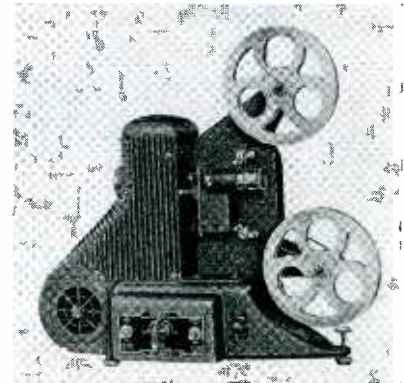

FALCON

Utility Mfg. Co., Inc.
New York, N. Y.



CAMERA — "Press Flash" provides its own light for pictures by means of a single button which operates shutter as well as the flash synchronizer for self-contained flash bulb. Can be used with or without flash bulb lighting. Uses standard 8 picture roll films, with picture size 2 1/4 x 3/4 in. With 4 extra bulbs retails at \$5.95.

PARAPHONE

Paraphone Hearing Aid, Inc.
Cleveland, Ohio

HEARING AID—Electrical hearing aid, light in weight which employs crystals in tone-reproduction but without the use of radio tubes. May be attached to the radio by utilizing the Paraphone radio extension. Available in bone conduction or air conduction types

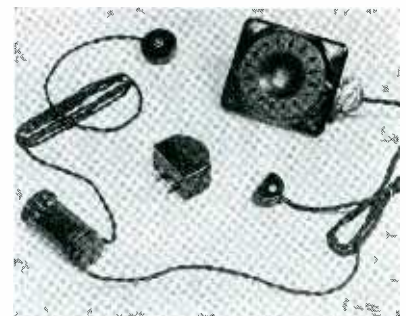

PREVUE OF NEW RADIO MERCHANDISE

CINAUDAGRAPH—Model WPE27 is a 27 in. electro dynamic speaker by Cinaudagraph Corp., Stamford, Conn., designed for music reproduction in large buildings and outdoor areas at high amplitudes. Power capacity, 85 watts, frequency range from 30 to 10,000 cycles.

CLAROSTAT—Wire-wound inorganic cement-coated non-inductive power resistors introduced by Clarostat Mtg. Co., Inc., Brooklyn, are built for ruggedness in operation. Non-inductive characteristics prove satisfactory up to 30 mc. Offered in popular wattages from 10 to 80 and in all popular resistance values. For dummy antenna applications, including accurate measurement of actual transmitter output and tuning of antenna systems and transmission lines without actually going on the air with interfering signals, the 73-ohm, 200, 400 and 600 ohm values in 80-watt rating are offered.

RECOTON—A liquid record renewer by Recoton Corp., 178 Prince St., New York, is claimed to remove dust and foreign particles from the grooves of the record, lubricate the needle's path and help preserve the original tone of the record.

VERTROD—Antenna designed for universal mounting on windows, gabled roofs, chimneys, parapet walls, etc. Three sections of nickel plated brass tubing which extend to 9 ft., mounted into a nickel-plated brass rotary joint allow motion of 240 degrees. Employs two iron core transformers, covers frequency ranges from 500 kc. to 20 mc. with ultra high frequency unit available. Alesi and Fener, 132 Nassau St., New York, N. Y. List \$8.50.

WEBBER—The latest tube testers made by The Earl Webber Co., of Chicago, have loctal sockets to accommodate loctal tubes without adapters. Testers No. 85 and 60 have additional spare sockets and switch positions for future tubes. Data on loctal tubes included on tester charts.

WESTERN ELECTRIC—Suited for use with speech input equipment in broadcasting systems or applications in schools, hotels, restaurants, and similar locations demanding faithful music reproduction and speech reinforcement over limited areas is the high quality monitoring loudspeaker 750A which Western Electric Company, 195 Broadway, New York, has made available. Its compact form houses a speaker which approaches performance of more elaborate two-way sound radiators employed in large public address systems.

GALE

Gale Products
Galesburg, Illinois

REFRIGERATORS—The line to which the illustrated refrigerator belongs consists of two series of 5, 6 and 7 cu. ft. models which incorporate advanced designing and convenience features throughout. DeLuxe models have patented sealed evaporator, lighted ice cube compartment, freezer shelf for fast freezing. Exteriors are of Du Pont Delux with satin chromium trim.

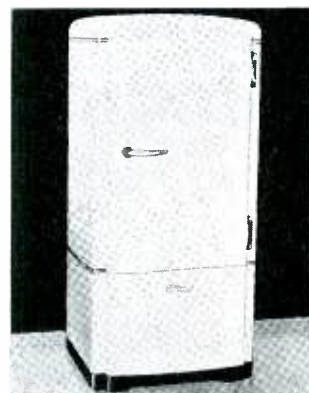

BITTER

A. Bitter Construction Co.
27-01 Bridge Plaza North, Long Island City, N. Y.



RECORD STOCK CABINET
—Model No. 27 for small inventory which can be expanded by adding units. Fitted with domes for placing on counter or shelf. Capacity one hundred twenty 10 or 12 in. records. Sprayed Duco walnut finish on sheet steel. \$4.50 f.o.b. factory.

Specialists in Producing RADIO REPLACEMENT SPEAKERS

Operadio Speakers are produced and placed in over a million radio receivers annually by the outstanding radio manufacturers in the country. Radio engineers, the men who design the sets, know that a receiver is no better than its speaker. Therefore, they specify Operadio. That is why more and more dealers, when making replacements, install Operadio Speakers.

Operadio's combination of radio replacement speakers and Uni-Matched Transformers enables you to meet any requirements. Because of the unique design of the transformers and the fact that the speakers themselves are of the direct-to-voice coil type, as many as six speakers can be used with the identical transformer. That means less inventory, less investment, maximum service at less cost. The Operadio line is complete . . . economical to stock and handle . . . competitively priced . . . second to none in operating efficiency and frequency response.

See your jobber or address Dept. RR2 for Speaker Catalog

Export Division:
145 West 45th Street, New York City



NEW!
Ask about our
4-INCH
Replacement Speaker
for Midget Sets

Also manufacturers of a complete line of Public Address Equipment, P. A. Speakers, and Intercommunicating Systems.



OPERADIO MANUFACTURING COMPANY ST. CHARLES ILLINOIS

Radio Retailing makes a report

*to its 158 advertising
investors in 1938*

Gentlemen:

During 1938 you invested over \$135,000 in Radio Retailing's advertising pages. We feel that you are entitled to a review of what you got for your money in the nature of an improved publishing service and a business-building tool.

*

CIRCULATION

During the year you received an *increase* of paid circulation amounting to over 3,900 readers (paid circulation of the November 1938 issue was 23,350). Most of these new subscribers were retailers, servicemen, and service dealers.

During this period the total average monthly distribution was over 25,000 copies. Based on our most recent surveys of readership, the pass-on circulation of Radio Retailing is estimated to be three readers per copy. Therefore, there is *every* indication that your advertisements were exposed to over 75,000 readers per month.

EDITORIAL

Behind the advertising values thus de-

livered to you is the educational and sales stimulating power of Radio Retailing's tremendous editorial potency.

During the year in the face of decreased advertising revenue, Radio Retailing not only maintained its editorial service, but *increased its editorial expense* to improve this service.

A few examples:

Radio Retailing initiated a national monthly check-up on retailers' radio sales and made this information available to manufacturers and sales outlets thru the "Monthly Barometer" published in the paper.

Radio Retailing conducted national surveys and issued complete reports to manufacturers covering the current business situation in the radio business in the spring, summer, and fall seasons of the year.

In addition to these, two further surveys were made and complete reports issued covering the Farm Radio market and the Sound Equipment market.

Radio Retailing gave to the industry the first comprehensive answer to its problem

of handling "trade-ins" with the publication of the "Radio Trade-in Allowance Blue Book."

As an extra service to the industry the Editor of Radio Retailing, in cooperation with members of the RMA, made personal appearances in Washington—

Before the Ways and Means Committee of Congress in an effort to eliminate the excise taxes on radio-sets.

Before the Federal Trade Commission to support those desirable portions of the code for fair trade practice for the radio industry.

Before the Federal Communications Commission to oppose any ruling affecting the progress of the radio industry.

In each instance Radio Retailing's editor was the only representative of the trade press in attendance.

As to Television, the industry's newest hope and problem:—Late in 1937 Radio Retailing sent its editor to England and Germany to study the commercial progress of television. Reports on this study were issued to the industry which, during last year, it found valuable for future planning. Radio Retailing has kept manufacturers and the trade up-to-date on all current developments.

Radio Retailing's editorial service is reflected to the fullest extent in its intensive readership. To say that it gave its readers 24% more editorial pages than its nearest competitor tells only part of the story of its leadership in the field. From your standpoint as an advertiser it represents our investment to guarantee the fullest returns on your advertising dollar.

ADVERTISING

While it is true that in 1938, due to adverse business conditions, you placed fewer advertising pages with Radio Retailing than in 1937, we are pleased to report that *your advertising investment with us was 10% greater in pages than in any other radio trade publication.* In dollars, this was *much greater.*

It is also significant that while your investment in advertising pages with Radio Retailing was reduced 20.5% from 1937 to 1938, it was reduced 30% with our nearest competitor—*a further indication of your preference of Radio Retailing as a sound investment.*

This is not, of course, intended to be a complete report on Radio Retailing's advertising values for 1938. Merely a few notes that underline the continued soundness of your judgment in placing your trade advertising in Radio Retailing.

Radio Retailing in its 13 years of service to the field has maintained its leadership on the unwavering premise that *a constructive service to its readers can not fail to create a profitable investment for its advertisers.*

Radio Retailing

A McGraw-Hill Publication

350 West 42nd Street

New York, N. Y.



TWO VETS—A. A. Schneiderhahn, one of the country's largest washer distributors (left) meets vet radioman H. G. Erstrom at Chicago's Stevens

Good Sign For '39

Housewares and furniture shows report orders up, Southwest buyers most active

CHICAGO—As Maine goes, so goes the Nation, generally speaking. As the sale of housewares and furniture goes, so goes radios and electrical appliances. Good news then to radio and appliance merchants is the fact that the Furniture Mart in Chicago saw \$85,000,000 worth of furniture and home furnishings sold in its wholesale January market, a gain of 25 per cent over a year ago. Buyers attending the Merchandise Mart Show saw an increase of around 35 per cent. Executives of both marts said that buyers from the Southwest, particularly Texas, made heavy purchases.

Attendance record of buyers made new highs, some 10,383 buyers registering in at the Merchandise Mart in its first three weeks, and 10,550 at the Furniture Mart up to this time.

At the Stevens Hotel show, made notable by the mass exhibition of washing machines and ironers, virtually every exhibitor reported a satisfactory business.

Sentinel, With Whiskers

CHICAGO—To winners in a "Sentinel Plays Santa" contest December 15 went 100 turkeys, 25 de luxe travelling bags, 25 movie cameras and projectors, and 25 Shavemaster electric razors. Sentinel Radio Corporation was the donor, lucky salesmen among those employed by 75 distributors the recipients.

General sales manager George W. Russell sponsored the contest and, incidentally, announced that for the second time in his career he had become a grandfather. Many stepped right up for cigars.

New Nest For Sky-Chief

NEW YORK—President Samuel Glick of the Sky-Chief Radio Corporation advises that his offices, showroom and factory are now located at 345 East 27th Street and that new models are to be ready February 15.

On the Newsfront

Tube Prices Studied

NRPDA thinks replacement business must be made more profitable

READING—From George D. Barbey, secretary of the National Radio Parts Distributors Association, comes word that a questionnaire has just been mailed to 1947 distributors (both members and non-members of the group) asking for suggestions as to how replacement tube business may be made more profitable. The Association believes that all jobbers handling replacement radio tubes have "long been playing with fire", plans to submit recommendations to manufacturers at the conclusion of the survey.

Questions posed for jobbers in the questionnaire include: "Do you think the tube business is in a healthy condition . . . If not, what changes in sales policies do you recommend?". "Do you suggest more discount . . . less discount . . . higher list prices . . . prices averaged into few groups . . . quantity prices, deals, premiums, free equipment?" "Do you believe a Judge Landis is needed in the radio industry?"

New RSA Affiliations

CHICAGO—Fort Wayne and St. Joseph service groups have just affiliated with the RSA. Officers of the Indiana group include Henry A. Schryver, E. Moennig. The Missouri boys are headed by Cleo Blodgett, E. R. Sullwold and Russell Goerhe.

Toledo secured details regarding pro-

cedure for affiliating with RSA, has formed a committee to lay the preliminary foundation. Organizing are servicemen in Pekin, Illinois.

Admiral Package Deal

CHICAGO—Continental Radio & Television Corporation has just created a special Unit Package Deal designed to promote rapid distribution of the complete new line of Admiral models.

To the ten jobber salesmen who move the largest number of packages to dealers by March 15 will go merchandise and cash awards.



AT ANOTHER TABLE—NBC-RCA's Mullen, snapped during the joint committee meeting itself



EVEN JOINT COMMITTEES MUST EAT—Members of the joint RMA-NAB committee, in Washington January 6 to map future plans to boost interest in radio, took time out to hear Secretary of War Woodring in an "off the record" talk at the National Press Club. Left to right facing camera: RCA's Joyce, NAB's Miller, RMA's Schuette, Philco's Ramsdell, RMA's Geddes

All Year Round Philco

Distributors assembled at Palm Beach see new radio line plus refrigeration, air-conditioning and dry batteries

PALM BEACH—Assembling here and awaiting the February 16 opening of the Philco Radio & Television Corporation's midwinter national convention as *Radio Retailing* closes are this manufacturer's distributors. From vice president Sayre M. Ramsdell this reporter learns that the firm will in 1939 feature the slogan "Philco All Year Round", extending production into other fields, backing up additional products with heavy advertising schedules.

Offered to Philco distributors will be a line of eight "Conservador" refrigerators, three standard, three special and two economy models. (Philco Radio and Television Corp. will guarantee and distribute these products of the newly organized Philadelphia Storage Battery Co. subsidiary named Philco Refrigerator Co., of which W. Paul Jones is president, W. R. Wilson treasurer, C. F. Steiruck, Jr., secretary. These men, with J. S. Timmons, also constitute the board of directors.)

Seen too will be air-conditioning products heralding Philco's first full year in the business. There will be three models, we understand, including a $\frac{1}{2}$ hp. window-sill type, a console of $\frac{1}{2}$ hp. and another console of $\frac{3}{4}$ hp. All will bear the name York-Cool Wave.

On the market, in addition, Philco will place a complete line of dry batteries, ranging from small flashlight cells through general purpose and ignition types to radio A, B, C units and pack combinations. They will be guaranteed against shelf deterioration for two years.

Careful to correct any impression that Philco might be diverting effort from radio was vice president Ramsdell, who stated that "radio is still Philco's basic business and will continue to be. . . .



ONE OF SIX—Just upped by RCA, one of six men advanced . . . David J. Finn, now advertising and sales promotion manager

And when we mention radio we include television which is, after all, an allied branch of the same industry." (Enroute from the Philadelphia laboratories at this writing is a portable television video and audio transmitter designed to permit demonstration of televisions during the convention.)

Complete details of the radio line to be shown distributors were not obtainable in time to make *Radio Retailing's* deadline but it was understood that among new models there would be two wireless record players, one a portable and the other an automatic record playing console providing space for albums. The success of a battery type portable introduced a short time ago is understood to have induced the company to build another including a spring-wound phonograph. At least one new auto radio model was expected, as were farm models.

Due also for introduction at the convention was promotion material plugging "Safety" antennas, a new handy tubular condenser kit for servicemen and a new tester incorporating a signal generator and vacuum-tube voltmeter.



NUMBERS—To Ken Hathaway Ralph (Ohmite) Hill's youngster Gene hands numbers grabbed from a bucket. They determine the booth space allotted to 76 companies participating in the coming National Radio Parts Trade Show



PLAYERS—Watching booth selection were Paul (Sylvania) Ellison, P.R. (Tung-Sol) Dawson, Charles (Cornell-Dubilier) Caine and MacMurdo (Guthman) Silver

RCA Ups Six

Joyce, Walker, Finn, Butler, Cook, Richardson advanced

CAMDEN—From George K. Throckmorton, president of the RCA Manufacturing Company, comes word that this firm's board of directors has elected Thomas F. Joyce vice president and advertising director, Frank B. Walker vice president in charge of all record activities.

Simultaneously, David J. Finn becomes advertising and sales promotion manager, Edward W. Butler becomes manager of the radio and Victrola division, Jay D. Cook becomes manager of the International division, Paul C. Richardson becomes head of a new educational sales division.

The duties of Ellsworth C. Dent, educational director, remain unchanged.

Westinghouse Appliances Shown

CHICAGO—A new electric ironer which can give clothes a tailored hand touch, a range which bakes biscuits from a cold start in eight minutes and a new refrigerator with a "true temp control" that maintains temperatures within a couple of degrees were introduced to Chicago and other distribution groups by Westinghouse Electric & Manufacturing Company in January.

In the refrigeration field, R. C. Cosgrove pointed out the rosy sign posts ahead in 1939: Rural electrification is coming to some 300,000 homes; 250,000 "old vintage" refrigerators will be replaced out of the 1,400,000 refrigerators which were purchased seven years or more ago. New housing and building plans plus last year's record crop of marriages make optimistic prospects.

H. B. Donley surrounded the show with table appliances on which Westinghouse expects to go to town in 1939.

Emerson Launches "Multiple-Sale"

Introduces \$6.95 "Emersonette" as leader to stimulate use of more sets per home. Obtainable only in proportion to other model purchases

NEW YORK—On the market just as *Radio Retailing* closes comes an Emerson Radio & Phonograph Corporation "Emersonette" receiver listing at \$6.95, built into a Walnut plastic cabinet 6½ by 4¾ by 3¼ inches overall, equipped with a 4-inch speaker and an illuminated dial. Red, green and ivory models are to be made available at 50 cents extra.

Leader in the firm's newly announced "Multiple-Sales" promotion plan, the model is to be made available to dealers only in proportion to purchases of standard models. In a statement issued to the press simultaneously with its release president Ben Abrams stated that introduction of this set should not in any way be construed as a competitive move. Said Mr. Abrams: "It is designed to serve purposes for which larger units are unsuited—for carrying in luggage, for tucking into desk drawers, for book-ends, for niches in playrooms and other small spaces."

Mid-season promotion plans announced by Emerson include heavy factory expenditures for silent window and store floor "salesmen," extensive advertising in newspapers and magazines, colorful literature and several point-of-sale promotional plans for dealers. In the opinion of Mr. Abrams, whose firm increased its unit sales 100 per cent and dollar volume 25 per cent last year, 1939 may see a total of 10,000,000 radios sold.

G-E Treads The Boards

Road show "Get Over Into Clover" to play in 50 cities

NEW YORK—To 50 key cities following a New Orleans premiere February 8 headed General Electric's appliance exhibit for distributors, replete with movies, professional actors, stage crew and sets. Two separate units are treading the boards, with the following schedule:

Eastern Unit: Memphis Feb. 10, Little Rock Feb. 13, Birmingham Feb. 16, Birmingham Feb. 16, Nashville Feb. 17, Atlanta Feb. 20, Columbia Feb. 23, Raleigh Feb. 24, Richmond Feb. 27, Charleston Mar. 1, Cincinnati Mar. 3, Louisville Mar. 6, Indianapolis Mar. 7, Columbus Mar. 8, Pittsburgh Mar. 10, Washington Mar. 13, Baltimore Mar. 14, Philadelphia Mar. 15, Williamsport Mar. 17, Lancaster Mar. 20, Allentown Mar. 22, Newark Mar. 23, New York Mar. 24, Hartford Mar. 27, Providence Mar. 28, Boston Mar. 29, Schenectady Mar. 31, Syracuse Apr. 3 and Buffalo Apr. 4.

Western Unit: St. Louis Feb. 13, Kansas City Feb. 13, Dallas Feb. 15, Houston Feb. 16, San Antonio Feb. 17, Los Angeles Feb. 20, Fresno Feb. 23, San Francisco Feb. 27, Portland Mar. 2, Seattle Mar. 3, Salt Lake City Mar. 8, Denver Mar. 10, Omaha Mar. 13, Rock Island Mar. 17, St. Paul Mar. 20, Milwaukee Mar. 22, Chicago Mar. 23, South Bend Mar. 24, Detroit Mar. 27, Toledo Mar. 28, Cleveland Mar. 29.



TOP EMERSON EXECS—Left to right: Advertising manager *Francis Solow*, chief engineer *Dorman D. Israel*, vice-president *Max Abrams*, president *B. Abrams*, merchandising counsel *Warren Lightfoot*, credit manager *Lillian M. Guth*, director of purchases *S. W. Gross* and sales manager *Charles Robbins*

Hi-Fi By Pacent

NEW YORK—The Pacent Engineering Corporation, of which Robert L. Lewis is general sales manager, is entering the set business as this issue goes to press. Specialty will be a remote controlled receiver available in kit form, wired or complete including a pickup and turntable, designed primarily for best obtainable audio tone quality and offered to people interested in such performance to the exclusion of "dx".

Pictured in assembled kit form elsewhere in this issue and shown schematically in the technical pages, the new receiver uses an extremely compact t.r.f. tuner, connected to a remote audio amplifier and auditorium type speaker through a flat cable 25 feet long.

Sonora Silver Sellastration

CHICAGO—Sonora Radio & Television's Joe Gerl says this concern will shortly celebrate the twenty-fifth anniversary of the introduction of the name Sonora in the music world with a Silver Jubilee. Planned are special models, special silver tags, special promotion and advertising . . . all intended to "say it with sales" and produce profit for the firm's distributors and dealers.

Monarch Sales Moves

NEW YORK—Monarch Sales Company, with which Al Saphin and Arthur Freed are associated, has moved from 261 Fifth to larger quarters at 230 Fifth.



FREQUENCY MODULATION ON THE ULTRA-HIGHS—When *Major Edwin H. Armstrong*, (left) demonstrated his frequency modulation system on transmissions from Alpine, N. J. and Yonkers, N. Y. to Bridgeport, Conn. engineers GE's *W. R. Baker* said his firm had a suitable receiver ready for release when a sufficient number of frequency modulated transmitters were available on the ultra-high frequencies

NEW LIGHT-WEIGHT MOTOR THAT KEEPS SPEED--and SELLS PORTABLES

BUY the new constant speed Flyer CX Phonograph Motors for your installations . . . Specify them in portables and table models . . . Sell them to assemblers. Latest General Industries development.

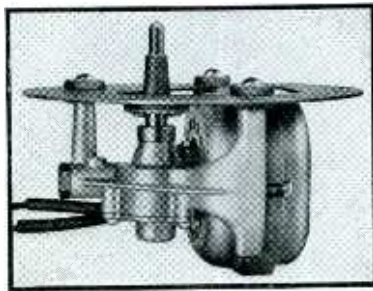

New Model CX. 8", 9", 10", 12" turntable included.

Self-starting. Quickly reach running speed. Free ventilation and fan-cooled operation. Ample oil reserve, in sealed chamber. Noiseless helical-cut gears, large bearings. Patented-drive turntable (not shown), gives positive insulation from motor.

Order a Model CX Flyer Motor

Get it now, for testing in your own case or cabinet. Specify frequency and voltage of current and size of turntable. Write today for Flyer CX catalog sheet and prices.



The GENERAL INDUSTRIES CO.

3937 Taylor Street

Elyria, Ohio

Janette Rotary Converters



For Converting D.C. to A.C.

Built for radio and sound apparatus—capacities 110 to 3250 volt amperes—with or without all wave filters. Dynamotor construction—economical to operate—ruggedly built for years of trouble-free service—used or recommended by the largest manufacturers of radio and sound apparatus—in use all over the world.

Why Experiment—Insist on a Janette

Ask for Bulletin 13-25

Janette Manufacturing Company

556-558 West Monroe Street Chicago, Ill. U. S. A.

A GOOD NAME GOES A LONG WAY



Ken-Rad Radio Tubes maintain their good name because of a thoroughly sound foundation of engineering skill and unexcelled manufacturing facilities

Ken-Rad Tube & Lamp Corp.
Owensboro, Ky.

KEN-RAD

DEPENDABLE RADIO TUBES

RADIO RETAILING, FEBRUARY, 1939

AGAIN BELL LEADS THE SOUND EQUIPMENT INDUSTRY!

A FULL LINE of NEW DESIGNS

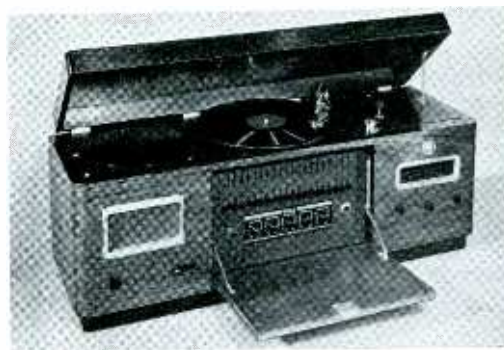

BIG NEWS made BIGGER

BELL'S NEW PANEL RADIO and TALK-BACK SYSTEM

For those alive to the profits in the fast-growing market among Schools, Colleges and Institutions, for economical high-quality Radio and Talk-Back Equipment, Bell's new desk-type panel system was BIG NEWS late in '38. Even bigger news is this announcement of a streamlined addition to the Bell line, designed to meet a larger market in '39! It tops the field in offering a dependable precision-built system at a sales-clinching price! Check these up-to-the-minute features carefully!

- Large Talk-Back Amplifier for Inter-communication • 25 Watt Amplifier with bass and treble compensation • All types of phonograph equipment available with unit—including record-changer or 16 inch transcription turntable (an exclusive feature!)
- 8 inch audible monitor • Radio tuner • New key-type room switches • Unit locks in sturdy, walnut-finished, desk-type cabinet • Provides for maximum of 40 room outlets • Master switch for emergency use • Many other important features!

NEW BELL P. A. SYSTEMS, TOO!

Typical of Bell's complete 1939 line is this new 15 watt, dual speaker, Public Address System. Smooth flowing design, dustproof gray finish, and numerous mechanical refinements place this new line far ahead of the field. New illuminated control panel, three input channels, new larger baffles, heavy-duty permanent magnet speakers, high-gain amplifier, octal series tubes, and many others! Readily portable in a single compact unit. Remarkably easy to service—amplifier cover fastens firmly with only two screws! Available with all current types of Dynamic, Crystal or Velocity Microphones. Illustration shows portable system; for permanent installation, units are available with walnut speaker baffles and pedestal microphone stands. In every respect the best buy on the market!



Write today for full information on Bell's complete line of newly-designed sound equipment

BELL

SOUND SYSTEMS, INC.

1185 Essex Ave., Columbus, Ohio
EXPORT DEPARTMENT:
5716 Euclid Avenue, Cleveland, Ohio

Northwest Sales Up 10%

Year end checkup produces encouraging totals despite \$10 average decline in retail set sales price

MINNEAPOLIS—Retail radio sales of sets, tubes, parts and service in the northwest showed a 10 per cent increase in 1938 over 1937, according to H. H. Cory, secretary of the Northwest Radio, Refrigeration and Appliance Association. Better than average performance is claimed for the area, the Association pointing out that national production of sets was down.

One hundred and fifty Minneapolis stores sold 30,700 new radios in 1938, while 95,000 sets were sold in the ninth Federal Reserve area excluding Minneapolis. Average retail price paid figured \$42.64. Replacement tube sales for the entire territory were estimated at \$390,000, replacement parts and aerials at \$352,150, labor charges for service work at \$344,000.

Total retail price paid for all new sets, replacement tubes, parts and service in Minnesota, North Dakota, South Dakota and parts of Wisconsin, Iowa, Montana and Wyoming was estimated at \$6,530,550. Sets went for approximately \$10 per unit less than in 1937.

Presto! New Plant

NEW YORK—Expanding for the fourth time in two years, the Presto Recording Corporation moved January 25 to 242 West 55th Street. Doubling of the space maintained for factory and offices on West 19th St. was necessitated by a 48 per cent increase in business during 1938 and a favorable outlook for 1939, according to exec Ralph Powell.

Presto discs will continue to be turned out at the company's Newark, New Jersey plant, opened last summer.

District Men Hear RCA Plans

CAMDEN—RCA Victor district managers from every part of the country heard company execs predict good business for 1939, outline the firm's sales, advertising and promotion plans here early last month.

Addressing fieldmen during the two-day meeting were Thomas F. Joyce, D. J. Finn, Fred D. Wilson, Paul C. Richardson, E. W. Butler, Ellsworth C. Dent, Frank B. Walker, L. W. Teegarden, W. L. Rothenberger, Harry F. Mickel and Homer B. Snook.

New Southwest Rep

DALLAS—The Hafer Company has been organized here, will represent manufacturers in Texas, Oklahoma, Arkansas and Louisiana. Tom Hafer heads the company. Grady Millican will contact Dallas, Fort Worth and vicinity trade. Jack Helliwell is also with the firm, which is employing salesmen in the chief cities of its area.



WHOLE MAJESTIC CREW—Here's the gang that makes Majestic radios move. Left to right, seated: Harry Klein, Lou Stutz, Frank Hawley. Standing: Art Wolf, Harry Byrne, Max Hoffman, Otto Bowman, A. L. Herzog, Dave Rest, Harry Olson, Jerry Weinstein, Ben Weiser, Jack Cather, Lloyd Banford and Ed Lundgren.



SURROUNDED—Placing a big parts order is Springfield, Illinois' H. W. Bruce (center) Pleased recipients are, left and right: Norman Kathrinus and Thordarson's general sales manager C. P. Cushway



NO BITTER CUP—To E. B. Hazie of San Diego Auto Electric from Powel Crosley, Jr. went the President's Cup for selling largest percentage of Crosley Shelvador refrigerator quota in 1938.



FEEDING CROSLLEY INNER MEN—Left to right at Crosley's January 6-7 Netherlands-Plaza convention in the Cincinnati hometown: W. J. Calsam, Anthracite Radio of Scranton; John J. Hope, Jr., Crosley's credit watchdog; Ernest Kronson, Ontario Electric of Buffalo; Lewis M. Crosley, factory exec. v-p. and C. E. Lytle of Mankato, Minnesota's Southern Minnesota Supply



Unit cabinet No. 100, walnut finish, for use independently or as a unit of a large record department. Holds 1000 records. 75 albums. Price FOB factory uncrated \$40.

Write for illustrated folder. Layout suggestions free.

Unit cabinet No. 26, walnut finish on sheet steel, for display and storage. Use flat on a counter or hang on wall. Holds 125 records. Price, F. O. B. factory, boxed, \$6.75.

SO EASY to get started in the sale of RECORDS!

and
Economical, too,
with the new
BITTER-BUILT
Merchandising
Equipment

**ADD A UNIT
AS YOU GROW!**

Cabinets for display
or storage, suitable
for any inventory—
large or small.

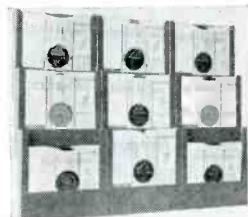

A. BITTER CONSTRUCTION CO.

27-01 Bridge Plaza North
Long Island City, N. Y.

Specialists in store modernization and store
equipment, serving many nationally-known retailers.

Now... Get **REAL**
RESULTS with
New 1939

BRACH Antennas

Scientifically Designed
to Insure—

- ✓ BETTER RECEPTION
- ✓ EASY INSTALLATION
- ✓ PERMANENCE
- ✓ SATISFIED CUSTOMERS
- ✓ GOOD PROFITS
- ✓ MORE SALES

The BRACH line is a complete
line and every item is priced
right. Large stocks on hand at
all times insure prompt deliveries.
Send for new catalog today!

World's Largest Makers of Antenna Systems

L. S. BRACH Mfg. Corp.

55-67 Dickerson Street

Newark, N. J.



Established 1906



HONOR FOR EARLE—James M. Earle of Woodlawn Radio, new president of Illinois Radio & Electrical Dealers Association. Other officers simultaneously elected: Arthur Becker, Jr., vice president; Howard G. Lowe, secretary; Edward B. Dublin, treasurer; David Ettelson, chairman of Board, M. A. Perrenot, vice chairman. J. G. Strader continues as executive secretary.

Oldest Victrolas Were Really Old

CAMDEN—From RCA Victor vice-president Tom Joyce comes word that out of 55,000 entries in his firm's "Oldest Victrola" search twenty people owning models made between 1906 and 1925 are shortly to receive \$250 cash awards. In addition, dealers through whom winning entries were made will receive \$250 worth of merchandise.

Fortunate dealers were: E. E. Forbes of Birmingham, Lansdowne Electric of Philadelphia, W. D. Murphy of Summit, N. J., Jenkins Music of Kansas City, Petersen-Harned-Von Mauer of Davenport, Oklahoma Appliance of Shawnee, H. Royer Smith of Philadelphia, Monteen & Dolezal of Wahoo, Neb., Wilson Music of Maplewood, Seymour Shop of New Canaan, Foster Shop of Lafayette, Market & Broad Radio-Music of Newark, Cicero Radio of Cicero, Wurlitzer of Columbus, Heim's Music of Danbury, Checker Electric of Cedar Rapids, Spiros of Hicksville, N. Y. and Wurlitzer of Cincinnati.

Univex Jacks Discounts

NEW YORK—Universal Camera Corporation has just increased trade discounts on the C-8 World's Fair Movie line including cameras priced from \$15 up, on the PU-8 projector line, new Iris candid camera and on the AF-4 and 5 folding cameras. All Univex merchandise is Fair Trade, according to general sales manager F. G. Klock, and thus protected against price cutting.

More Furniture for Grand Rapids

GRAND RAPIDS—The Grand Rapids Woodcraft Corporation has purchased the cabinet division of Edwin I. Guthman and Co., Inc., former Guthman vice president in charge of this division Joseph Wolf becoming president of the Grand Rapids firm. Guthman will concentrate on coils, condensers, wire, amateur parts and kits.

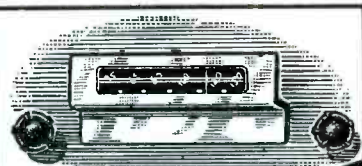

BUICK
'39

CROWE
Custom Styled
Remote Controls
for
**AUTO
RADIOS**

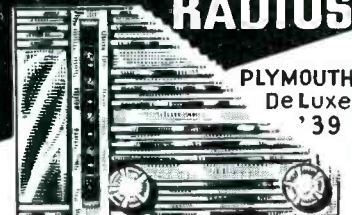

PLYMOUTH
De Luxe
'39

CROWE again leads with an outstanding line of CUSTOM-STYLED Remote Controls and Panel Mounting Kits for Auto Radios in 1939 cars. These Controls and Kits are officially styled to provide individual matching of specific car designs.

Flexible Stock

With their interchangeable feature, which fits the instrument panel of almost any car, Crowe Controls and Panel Kits make the dealer's stock of radios much more flexible. Crowe Controls and Kits are equally suited for new jobs, replacements or transfers.

Official Styling

True Custom Styling is a feature for which Crowe Controls and Kits are noted. They complete the panel design and provide correct appearance. Escutcheon plates perfectly match the design ensemble.

Crowe Controls Span Five Years

Taking in a span of five years, Crowe Controls and Kits can be used for '39, '38, '37, '36 and '35 cars—carrying out the designer's official styling. Thousands of radios, still in use after years of service, offer a profitable service business.

Ask for Bulletin 230

Crowe Name Plate & Mfg. Co.
1745 Grace St. Chicago, Ill.

**ARVIN • PHILCO •
DELCO • EMERSON**

• FADA • FIRESTONE • STEWART-WARNER • KARADIO • SPARTON • ADMIRAL • TRAVLER •

• HORN • TROY • MISSION-BELL • PACKARD-BELL • TIFFANY TONE • SPARTON OF CANADA •

ANOTHER Fast Selling Item From Regal Amplifier

Instant "Two-Way" Master-to-Master Selective System

Here's the inter-communicating system you can sell to the most particular customer. Provides for instant two-way private conversation between any two stations with a total selection of ten stations. Consider the wide range of uses, the attractive sales features, of this "Tokfone" Model 510. Surely it's the system that will close many a sale for you.

Five separate and distinct conversations can be carried on simultaneously as "Tokfone" Model 510 is a complete private telephone switchboard in itself. No "Talk-Listen" switch is necessary when using earphone.

Write for more information on Model 510. You'll find it the solution to many of your customers demands for a private, practical intercommunicator at a reasonable price.



Tokfone Master Station including earphone, "on-off" and "talk-listen" switches, volume control, 50 feet of wire **\$45.00**

Write for catalogue showing all new models

REGAL AMPLIFIER MFG., CORP.

14-16 West 17th St.

New York, N. Y.

WARD AERIALS ARE EASY TO SELL -EASY TO INSTALL FREE!

Write for new catalog of Ward's complete line of low-priced manufacturers - approved aerials for car and home - also get on mailing list for free magazine packed with selling and service tips.

**WARD
PRODUCTS
CORP.**

**WARD BLDG.
CLEVELAND, O.**



FETES BEST YEAR IN NINE—Here's the crew of Jenkins Music's Tulsa branch banquetting to celebrate their best radio year since 1930. Stromberg-Carlson set increases were largely responsible

Distribution News

STROMBERG-CARLSON—*Ken Gillespie*, radio sales manager of this firm's Kansas City branch, has taken over southern Nebraska as well. *Ted Holzem* is contacting the trade in western Iowa and northern Nebraska in addition to the territory formerly traveled.

MUELLER—*L. B. Putnam* of Denver has this line exclusive in Montana, Wyoming, Colorado, Idaho and Utah.

SENTINEL—New factory reps: *E. J. Jordan*, working California, and *Sanford Samuel*, serving New York, Philadelphia, Baltimore and Washington territory.

QUAM-NICHOLS—*William E. McFadden* of Columbus now has this line in Indiana.

HOWARD—Colorado, Utah, Wyoming and New Mexico representation on the

amateur receiver line goes to *Richard A. Hyde* of Denver. *H. E. Walton* of Detroit reps the amateur receiver line in Michigan and Indiana.

NASH—*Saul Shapiro* of Los Angeles is the new rep for his area on this St. Louis firm's line of recording lubricants and cleaners.

UNIVERSAL—*Jim Kay* of Tulsa has this concern's microphone line as factory rep in western Missouri, Oklahoma, Kansas and Arkansas.

ADMIRAL—From *J. H. Clippinger*, who has just returned from a west coast trip, comes word that the following jobbers have been appointed for Continental Radio & Television Corp.: *Marshall-Well* of Portland, and Spokane, covering Oregon and Washington; *Electric Supply Company* of Sacramento, *Pacific Wholesale* of San Francisco and *Herbert H. Horn* of Los Angeles.



ONE BIG FAMILY—The staff at Shuler Supply, New Orleans parts distributor. Left to right, kneeling: *J. Cota* and *H. J. Ballam*. Standing: *Miss A. Kusterman*, *Miss N. Catalanello*, *W. A. Shuler*, *J. Cerniglia*, *R. L. Baker* and *L. Gallo*



TAKES TRIPLETT FIRST—Here's lucky *Herbert L. Holmes*, of Marshfield, Missouri, who cops first award in the Triplet Service Puzzler competition, \$250 worth of test instruments. Other winners, in order, include *Floyd A. Martin* of Columbus, *Claude Lydick* of Kansas City, *Don M. Wherry* of Jefferson, Iowa, *Reynolds Schwemberger* of Toledo and *John Edmondson* of Franklin, Indiana

SENTINEL—*E. J. Jordan* is this firm's new factory rep, covering California. *Stanford Samuel* takes over New York, Philadelphia, Baltimore and Washington territories on the same basis.

NEW PACKAGING — All *Freed Transformer* products are now packaged in new three-color containers, contents plainly marked on outside.

PRESTO—*Chicago Musical Instrument Company* takes over distribution of a new line of Presto combined portable recorders and sound systems ranging in price from \$275 to \$595, ready for delivery March 1.



RCA RECORDMAN EARLY — *W. Wallace Early*, with the company since 1923, is RCA's new manager of recording and record sales. *John L. Hallstrom* will assist him. Both appointments have just been announced by *Frank B. Walker*, manager of RCA Victor's record division

THE TWO BEST SELLING NEW 1939 MOVIE CAMERAS!



MODEL C-8 Many Sensational New Features

\$15
With Faster
f4.5 Lens

Make Front Page News!

- Faster *f* 4.5 lens!
- New lens shade to prevent glare!
- New built-in optical view-finder!
- New snap-lock hinged cover for Quick loading!
- New, improved governor!
- New automatic self-closing shutter!
- Backed By Most Dynamic Advertising Campaign In All Home Movie History!

NEW!

**Model B-8 Complete With
OPTICAL VIEW - FINDER**

\$9.95 Only 8 mm. Movie
Camera at This
Sensational Low Price!

- New True-View Optical View-Finder!
- Quiet-running, powerful spring motor!
- New-type self-locking film spindle!
- New antique bronze finish!

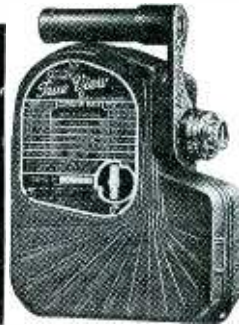

How's Your Film Stock?

The picture-taking season is just beginning! Don't get caught short! Check your Univex film stock now!

CINE FILM

No. 100 Standard 69¢
No. 100 Ultrapan 95¢

MERCURY FILM

18 and 36 exposures .. 30¢-50¢
ULTRACHROME—No. 00 10¢
ULTRAPAN—No. 00 15¢

Sensational New Guarantee Insures Your Movies!

Both new 1939 Univex Cameras carry this sensational guarantee: "Satisfactory movies or a new roll of film FREE!"

**Improved Univex
Projector!**

\$14.95

Only precision-built
8 mm. projector
UNDER \$30

**A.C.—D.C.
MODEL
\$17.95**

- 30% more illumination
- New film gate
- More powerful
- Shows clearer, steadier movies!
- Projects ANY 8 mm. film!
- Approved by underwriters laboratories

Universal Camera Corporation

NEW YORK . . CHICAGO . . HOLLYWOOD

FAIR TRADE PROTECTED IN 43 STATES

IT PAYS TO FEATURE THE NEW 1939 UNIVEX LINE!



NEW MODEL AC-DC
DUAL VOLT
35000 WATT
PRECISION WORKING
STURDY COMPACT
LIGHT WEIGHT
MORE TYPES IN STOCK

COMPLETE ELECTRIC PLANTS

ONAN A.C. ELECTRIC PLANTS supply electricity to operate A.C. RADIO, SHORT WAVE TRANSMITTERS AND RECEIVERS, PUBLIC ADDRESS SYSTEMS, MOVING PICTURE PROJECTORS, SOUND TRUCK APPARATUS, ELECTRIC TOOLS, LIGHTS and ALL APPLIANCES.

THOUSANDS IN USE IN ALL PARTS OF THE WORLD

Used as **STANDBY EQUIPMENT** in Schools, Hospitals, Theatres and Public Buildings, for Emergencies caused by Power Line Failure due to Storms, Floods, and other Catastrophes. Save Property and Lives. Other Models for Farms, Camps, Homes.

Available in 110 or 220 Volt, AC—12, 32 and 110 Volt, DC—also Dual Voltage, AC-DC Types, Manual, Full-Automatic or Self-Starting. \$99 and up. Shipped **READY TO RUN.**

WRITE FOR DETAILS AND PRICES

D. W. ONAN & SONS

445 ROYALSTON AVE. MINNEAPOLIS, MINN.

Servicemen!

You've waited for a **COWL AERIAL** which requires **NO DRILLING** of the finished body surface

RADIART Type CB-1
LIST PRICE \$2.45
"Radiart Engineered"
 for faster installation. Holes drilled under the hood lacing, do not mar body finish



Bulletin
 No. 639
NOW READY FOR YOU
 and full of New Ideas



THE RADIART CORP.
 Shaw Avenue • Cleveland, Ohio
 Manufacturers of
RADIART VIBRATORS
Guaranteed 1 YEAR

Now! BALLAST REPLACEMENT

made **AMAZINGLY SIMPLE**

- Servicemen, with only 4 standard types of Amperite AC-DC Regulators you can replace 90% (over 100 types) of AC-DC Ballast Tubes now in use! Consult your jobber.
- Amperite Regulators are equipped with a patented Automatic Starting Resistor to prevent untimely burnouts and save pilot lights.
- New Low Price on Amperite AC-DC Regulators: \$1.00 LIST

Amperite Replacements for 2V Battery Set ballasts \$1.25 list

AMPERITE Company
 561 BROADWAY
 NEW YORK



WRITE FOR CHART A-R

AMPERITE
 AUTOMATIC REGULATORS

Daco Service Club Formed

CINCINNATI—The "Daco Radio Club" has just been formed by the Dayton-Acme Company of this city, will include in its membership men who purchase test equipment made by the firm and bring to them periodically data about circuits, tubes and testing technique innovations.

Dayton-Acme, for some time specializing in the servicing and repairing of "Dayrad" test equipment, has just announced a new line of "Daco" testers including a test bench complete with all instruments, tool compartments, book-keeping facilities for the serviceman.



NO BEGINNER—David E. Johnson, vice president and general sales manager for Dayton Acme, is an old timer in the radio test equipment game, founded and headed "DayRad"

Ghirardi's New Book Out

NEW YORK—Alfred A. Ghirardi's new "Radio Trouble-Shooters Handbook" (Radio & Technical Pub. Co., 45 Astor Place, \$3) is off the presses, uses an 8½ by 11 page size, has 52 sections and 134 illustrations. Bound in black Fabrikoid meant to stand rough handling in the shop.

McFadden, New Rep

COLUMBUS—William E. McFadden has opened up shop at 256 East Gates, representing radio equipment manufacturers in the Ohio, Indiana and Kentucky territory.

Dealer Helps

BEER COASTERS—Coin phonograph operators will like *RCA Victor's* new beer coasters bearing thumbnail biographies of Benny Goodman, available through musical merchandise distributors.

PERIOD PICTURES—Mer s man Brothers' *Brunswick Radio Division* has a new folder picturing the entire line of radios encased in period furniture, with prices et al.

LESS RESISTANCE TO RESISTORS—That's what a new bright yellow and black counter or wall card by *Clarostat Manufacturing Company* of 285 North Sixth St., Brooklyn, is supposed to bring about when used by jobbers or dealers. Holds twenty Clarostat 10-watt green cement-coated power resistors of the fastest selling values between 25 and 25,000 ohms. Ingenious metal clips permit immediate removal or replacement. Orders for full quota of resistors required by the display brings the card without extra cost.

AVNET'S ANTENNAS—The *Charles Avnet Company* of 156 Chambers, New York, has its new 1939 catalog ready for distribution on request. Gives all data on firm's line of auto and home-type antennas, including new "Trim-Masts."

ESCUTCHEONS, A-R TOOL—*Star Machine Manufacturers, Inc.* of 1377 East Bay Ave., Bronx, N. Y., has just brought out catalog 391, describing a new line of custom-matched auto radio escutcheon plates, a new auto-radio flexible shaft tool, will send one to dealers or servicemen writing on company stationery, mentioning *Radio Retailing*.

COMPARISON CAMPAIGN—South Bend's *Bendix Home Appliances* has just put out an elaborate two-color folder telling the retail world all about its ambitious plans for 1939 promotion of the Bendix Home Laundries, including details of a May 18th Havana cruise.

SILK-SCREENED FABRIC—That's what a new Philco display is made of. Stands 5½ ft. high, colored in blue, gray and gold. Shelves accommodate up to 8 small sets.

Readrite
METER WORKS

KEPT UP-TO-DATE

Always

COMPACT

NEW MODEL 432

only \$21.60

COMPLETE IN QUARTERED-OAK CASE

ATTRACTIVE TUBE TESTER

Checks All Types Radio Receiving Tubes

Including the New 1.5 and 50-Volt Series: Local Base Types and the OZ4 and other Gaseous Rectifiers.

- Separate Plate Tests on Diodes and Rectifiers
- Neon Short and Leakage Tests
- Ballast Tube Continuity Test
- Uses Attractive Triplett Direct Reading Instrument 3" Size. (GOOD-BAD) Scale.
- Line Voltage Adjustment
- New Improved Low Loss Switch

Suitable for counter or portable use. Blipping etched panel of silver and black.

Model 431.....\$15.90

(Checks all receiving tubes. (No ballast or gaseous rectifier test.) Tester uses dependable Readrite Meter. Quartered-Oak case same as for Model 432. Write for Catalog—Section 220 College Dr.

READRITE METER WORKS Bluffton, Ohio



CRACKED 109 — Stromberg-Carlson's energetic radio sales manager *Lee McCanne*, who recently announced that his firm's 1938 average unit sale averaged over \$109, thinks '39 will be even better, lays out an ambitious promotional campaign to make sure

SMART SET SALESMAN — New *Admiral* table and portable types display well in a swanky combination counter and shelving rack just made available to the firm's dealers. Plays up "Aeroscope" magic antennas used in these sets, uses clever "Smart Set" slogan.

Attend the National Radio Parts Trade Show

1939 JUNE 1939			
WED	THU	FRI	SAT
14	15	16	17

OPEN ONLY to Jobbers, Manufacturers, Manufacturers' Agents, and Manufacturers' Engineers.

OPEN to Servicemen, Amateurs, Retailers, Student and others.

Stevens Hotel, Chicago

COILS, CHOKES, COUPLERS—*Edwin I. Guthman & Co.* of 400 South Peoria, Chicago, has a flock of new catalogs ready. Cover new coils, i.f. transformers, chokes, trimmers. Include six pages on the Frequency Meter-Monitor and four on the Diversity Coupler. Separate folder on communication receiver kits.

HILL-BILLIES—*RCA Victor*, in a new semi-annual catalog, lists Bluebird hill-billy and race recordings. Numbers listed alphabetically by titles in addition to classification by artists and types of music. Includes many pictures, 35 pages over all.

PANELS, RACKS—Available from the *Falstrom Company* of Passaic, N. J. are two new catalogs giving details on the firm's line of panels, racks and other steel products used in the radio and allied fields.

ELIMINATORS — *Electro Products Laboratories* of 549 West Randolph, Chicago, offers free-of charge to the trade a new two-color catalog sheet giving all specifications on its line of A and A-B eliminators.

CHIMES—To readers of *Radio Retailing* who care to write for it *Rangertone, Inc.*, of 201 Verona Ave., Newark, N. J., will send a six-page mimeographed folder giving prices on its chime producing mechanisms, rolls and accessories for same, "Towertone" amplifying system, speakers, amplifiers and other components, phonographs, and associated equipment.

NEW SPEAKERS FOR OLD—Spearhead of an *Oxford-Tartak* campaign for more replacement business are new dealer help folders telling the consumer that old sets may generally be materially improved by replacing obsolete speaker types with new *Oxfords*.

METAL SIGN—A 20 by 15 inch metal sign painted in five colors on both sides and varnished, with metal bracket, features *Tung-Sol* tubes and radio repairs. See company wholesalers.



AUTO RADIO CONTROLS

Simplest of all to install
THE ONLY CONTROL WITH ALL RATIOS SELF CONTAINED
Works clockwise or counter-clockwise with same dial
Absolutely no back-lash. No cord, no cable, positive gear drive
No mutilating of instrument panel
100% universal in every way
No excessive stock to carry

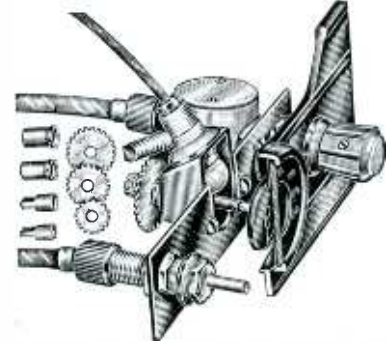

Complete line of 1934 - 35 - 36 - 37 - 38 and 1939 custom matched escutcheon plates with edge illuminated non-glare glass dials.



Chevrolet 1939

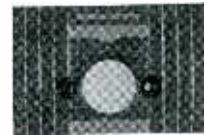

1939 Chevrolet Special—No. 393X



Pontiac 1939



Ford 1939

for re-installation any 1936 - 37 - 38 Delco, United Motors or Chevrolet custom radio in 1939 Chevrolet, only this plate necessary utilizing original control. Heavy die casting — exact duplicate original dummy plate — makes excellent custom matched installation.

Send for new illustrated catalog No. 391

STAR MACHINE MFG'S, Inc.

1377 East Bay Ave., Bronx, N. Y. C.

Cable Address: STARCON—NEW YORK



THERE'S REAL VALUE IN EVERY SENTINEL MODEL!
VALUE THAT SELLS!!

Sentinel

QUALITY RADIO SINCE 1920

AC
MODELS
FARM
MODELS

A
COMPLETE
LINE
SENSIBLY
PRICED

Sentinel Radio Corporation · Dept. RR · 2222 Diversey Pkwy., Chicago

FCC MICROSCOPES STANDARDS

HATCHETS STILL OUT—Either the telecasting tribe itself is not quite certain that the time is right to jump the experimental reservation and stage initial raids on consumer settlements, or it is convinced that the wampum for initial programming must come out of its own war-chest. For during the fiscal year just ended the Great White Fathers of the FCC release as news the fact that it received no requests from experimentally licensed telecasters for permission to peddle time.

Heap more pow-wow with aforementioned Big Chiefs, too, appears likely regarding RMA-proposed technical television standards, with all manufacturers on the reservation still not exactly in peace-pipe harmony. Failure to agree among manufacturer wigwams, no doubt prompted the following late January FCC newspaper statement: "It is generally agreed that television is not ready for standardization or commercial use by the general public."

NU BUILDS TELE LAB

FREE ADVICE—Month's most tangi-evidence that manufacturers are proceeding with practical video equipment production plans, despite fog which always obscures the vision somewhat in a new art, is National Union's announcement that it is setting up a television testing laboratory under the joint direction of W. M. Perkins and M. G. Nicholson, will offer the facilities of this lab free of charge to televisor manufacturers.

Scientific testing apparatus now in process of design to do a specialized job on video circuits and equipment will turn the place into a veritable proving-ground for all engineering and consumer angles.

EAMAQ HEARS SLEEPER

ACTIVE ANDREA—The Electrical Appliance Merchants Association of



SEE ANDREA'S TELEVISION—Queens (Long Island) dealers saw new Andrea televisions at their Association meeting last month, heard the firm's M. B. Sleeper talk. Here's part of the attendance, Frank A. D. Andrea himself fourth from left

Television Tomorrow

U. S. Experimental Television Stations

Licensee and Location	Call Letters	Frequency Bands in Kc.	Power in Visual	Watts Aural
Columbia Broadcasting System New York City	W2XAK	42,000-56,000 60,000-86,000	50 (CP)750	750
Don Lee Broadcasting System Los Angeles	W6XAO	42,000-56,000 60,000-86,000	1,000	150
Allen B. DuMont Laboratories Upper Montclair, N. J.	NEW (CP)	46,000-56,000	50	50
Farnsworth Television Inc. of Pa. Philadelphia	W3XPF	42,000-56,000 60,000-86,000	250	1,000
First National Television Inc. Kansas City	W9XAL	42,000-56,000 60,000-86,000	300	150
General Television Corp. Boston	W1XG	42,000-56,000 60,000-86,000	500	...
Kansas State College of Agriculture & Applied Science Manhattan, Kan.	W9XAK	2,000-2,100	125	125
National Broadcasting Co. New York City	W2XBS	42,000-56,000 60,000-86,000	12,000	15,000
National Broadcasting Co. (portable) New York City & Camden, N. J.	W2XBT	92,000 175,000-180,000	400	100
Phileo Radio & Television Corp. Philadelphia	W3XE	42,000-56,000 60,000-86,000	10,000	10,000
Phileo Radio & Television Corp. Philadelphia	W3XP	204,000-210,000	15,000	...
Purdue University West Lafayette, Ind.	W9XG	2,000-2,100	1,500	...
Radio Pictures Inc. Long Island City, N. Y.	W2XDR	42,000-56,000 60,000-86,000	1,000	500
RCA Manufacturing Co. (portable) Camden, N. J.	W3XAD	124,000-130,000	500	500
RCA Manufacturing Co. Camden, N. J.	W3XEP	42,000-56,000 60,000-86,000	30,000	30,000
RCA Manufacturing Co. (portable-mobile) Camden, N. J.	W10XX	42,000-56,000 60,000-86,000	50	50
University of Iowa Iowa City, Ia.	W9XK	2,000-2,100	100	...
University of Iowa Iowa City, Ia.	W9XUI	42,000-56,000 60,000-86,000	100	...
Zenith Radio Corp. Chicago	W9XZV (CP)	42,000-56,000 60,000-86,000	1,000	1,000

CP — Construction permit as of Nov. 1, 1938.

Queens (N. Y.) January 16 heard Milton B. Sleeper of the Andrea Radio Corporation discuss trade television angles at the Elks' Club of Elmhurst. Milton had Andrea video receivers on hand to show the 200, said also that his firm would make kits.

Continued absence of the Empire State

telecaster from the air prevented an actual demo but Sleeper pointed out that it "wouldn't be long now."

DUMONT TO SHARE TIME?

NEWS FOR NEW YORKERS—DuMont's Passaic television transmitter is going up with a rush, may get on the air in February. We hear that, initially at least, it will probably share time with NBC's Empire State, pictures on 46.5 mc. and sound on 49.75.

The CBS installation in the Chrysler Building is expected to start putting out about May 15. Main studio in the Grand Central Terminal Building.

GUINEA PIGS, ET AL.—Nifty of the month, so far gathered in solely by *Radio Retailing's* reporters, is a suggestion by Stewart-Warner's J. S. Knowlson to the effect that televisions sold this year be equipped with tags reading as follows: "This is to inform you that you are being used as a guinea pig for television experiments. Please remember, however, that though television is still experimental, a guinea pig can have a swell time."

..... **WASHINGTON WAG**—RCA-NBC television trucks brought legislators in the nation's capitol their first

home-grounds view of high definition television last month, was so favorably received that the company announced it would definitely televise the inauguration of the next President of these United States in '41. Asked to comment after the demonstration, Speaker William B. Bankhead of the House remarked that it "might make some members take their feet off the desks and quit chewing tobacco."

HAVE YOU SEEN MY OPERATION?—Brooklyn's Israel Zion Hospital, according to the American Television Corporation, is installing television equipment between operating room and gallery, enabling medical students to actually see (by direct wire) the scalpel scalp.....

HE SHOULD KNOW—At a recent stockholder's meeting of Scophony, Ltd., in England, managing director Solomon Sagall predicted that within a year, or two at most, American television will outpace developments in Europe. He thought competition among telecasters (The government holds a transmitting monopoly in England) would turn the trick, said he planned an American subsidiary.....

WORLD'S FAIR 1939—RCA will not only expand space originally contracted for over at Grover Whalen's shindig on Long Island to better demonstrate television but will also set 'em up at the Treasure Island Fair opening February 18 in San Francisco. Observers agree that television demonstrations at the New York World's Fair 1939 will probably constitute the initial barrage for a general advance along the television front.....

GE TELECASTS—Within the next three months General Electric will place in operation atop 1500 ft. "Indian Ladder" near Schenectady a 10-kw. television transmitter operating in the 66-72 mc. band.....

FARNSWORTH RUMOR—Directors of Farnsworth Television & Radio Corporation, until recently Farnsworth Television, Inc., have elected E. A. Nicholas president. The firm is rumored to be dickering for the Marion, Indiana, radio factory once owned by Grigsby-Grunow and now by General Household Utilities as well as a plant at Fort Wayne owned by Capehart.



SWANK, REP—*Wally B. Swank*, now representing several leading radio and amateur parts makers out of Detroit (610 Blaine Ave.), is hitting both jobbers and industrial accounts on his own these days. Used to be with General Household

WHAT'S AHEAD IN AUTO-RADIO

(Continued from page 17)

bumper types. . . . *Avnet* features a similarly complete line, calls particular attention to new and attractive heart-shaped insulators (Ed. Note: Spring is coming and most auto-radio fans are young, at that!). . . . *Brach's* new catalog, rushed to us just before closing, includes about every conceivable antenna type . . . and *Burton-Rogers* tells us that in addition to making conventional car antennas special stuff for transmission or reception on the ultra high frequencies (police, fire

department, amateurs, et. al.) new rods using "methacrylate" insulation are available. . . . Pioneer's *Col-Mar* vacuum operated antenna has been slicked-up so that it looks and works even better than last year. . . . *Ward Products* has a new auto-radio antenna line. . . . *JFD* said several important improvements were nearly ready in its antenna line. . . . *Star Machine* had an inexpensive flexible cable tool in production. . . . *Crowe Nameplate* is preparing to ship samples of a brand new instrument panel matching dial line.

Yours free! a new
SIMPSON
Tube Tester

BUY ONLY 19 NATIONAL UNION TUBES AND/OR ELECTRO CONDENSERS PER MONTH—ASK YOUR N. U. JOBBER

It's a little beauty, this new Simpson Tester! Light weight, small size, compact, great big easy reading meter. Just the kind of instrument you need for all 'round work. In addition to tubes, it tests pilot lamps, Christmas tree bulbs, ballasts, gas rectifiers. Tests for noise and shorts.

For complete technical data consult your National Union jobber. He's ready to GIVE YOU one of these testers on an amazingly attractive N.U. offer. Small deposit refunded as merchandise credit when your contract is complete. Get details NOW!

TESTS SINGLE ENDED AND LOKTAL TUBES

You can always use an EXTRA tube tester . . . let your N.U. Jobber give you one of these new SIMPSONS!



Come on!

BUILD CUSTOMER CONFIDENCE with NATIONAL UNION RADIO TUBES and CONDENSERS

NATIONAL UNION RADIO CORP.
Newark, New Jersey RR-239
Who is nearest Nat. Union Jobber?
Name
Street
City..... State.....

EDUCATION IN A CAPSULE

(Continued from page 19)

we have in stock and reduce the price from \$100.00 to \$89.50. Won't make much money, but I'll sell the stock I have."

As a matter of fact, a dealer is apt to lose money on a deal like that, as a study of the chart below will indicate. Our purpose in presenting this material is—not to discourage the making of special

offers, but to encourage a careful consideration of them before making a decision. Better to spend a few earnest moments with a pencil beforehand than a few hours with a headache when the month's profits are figured.

The regular price of merchandise is assumed to carry the operating expense, including profit. The chart below shows exactly how much additional volume must be done to break even at the various percentages of price cut.

BREAK-EVEN TABLE							
Operating Expenses	P.C. of Price Cut	P.C. of	P.C. of	V.I.N. = Volume P.C. of	Increases P.C. of	Needed P.C. of	P.C. of
	5%	10%	12½%	15%	16 2/3%	20%	25%
20%	V.I.N. 33%	100%	167%	300%	488%
25%	V.I.N. 25%	67%	100%	150%	200%	400%
30%	V.I.N. 20%	50%	68%	100%	125%	200%	500%

IRRESISTIBLE SALES TALK

(Continued from page 25)

to get more than they'll use right away, afraid it will spoil. And this doesn't apply only to strawberries.

"Now take the third way you save, by buying at any time you wish. You can buy when the price is low, whether you're ready to use

the food or not. Take meats, for example. Let's say you want to have some kind of roast for Sunday dinner, Mrs. Jones. When would you get it? Saturday night? Of course you would. Because you wouldn't want to keep it any longer than you had to, before using it.

"And do you know how much

you'd pay for it Saturday night? Anywhere from three to seven cents a pound more than you would if you bought it earlier in the week and kept it nice and fresh in your electric box until you were ready to use it.

"Suppose it's a six pound roast, say. And say you save only three cents a pound. There's eighteen cents, Mrs. Jones.

"So you see how you save? A little here, a little there. You save without even realizing it usually. These pennies don't seem like much, taken separately, but they add up.

"So what's the answer? The answer is that you are going to pay for this box, even if you don't buy it. So why not have it, Mrs. Jones.

Get Into the Kitchen

We settle back and relax a little, now, just to see if there is any resistance left.

"Forget the convenience. Forget how proud you'll be of it after you get it. Forget how nice it's going to look—incidentally, Mrs. Jones, where would you put it?"

We're walking out into the



Electricity for Farms . . . Homes

"GOLD CROWN"—HEAVY DUTY POWER PLANT. Available as follows: 32 or 110 volts D.C., also 110 and 220 volts A.C., 600, 1000, 1500 watts and up. Electric starting, air or water cooled.

"BLUE DIAMOND"—COMBINATION A.C.—D.C. POWER PLANT. All New "2-in-1" electric plant supplying 300 watts, 110 volts A.C. 60 cycles; also 200 watts, 6 volts D.C.; 250 watts, 12 volts D.C. or 325 watts, 32 volts D.C. Electric starting.

PIONEER GEN-E-MOTOR CORPORATION

Dept. R-1B, 466 W. Superior Street, Chicago, Ill.

Please send me literature, price sheets and other information about the New "PINCOR" GOLD CROWN and BLUE DIAMOND Power Plants.

Name

Address

City State.....



EVERYBODY

wanted it . . . it's HERE!

Fast-selling and profitable is this great RECORD RENEWER on its brilliant display card! Removes dust and grit, lubricates record grooves, preserves quality and lengthens playing life of records. Big 2 Oz. bottle retails at 50c. Just what your customers are looking for. Send for sample . . . QUICK!

Ask for samples of SUPERIOR and ACOUSTIC hi-fidelity needles

RECOTON
CORPORATION

178 Prince Street New York City



THE Eyes HAVE IT!

Solar
Capacitor Analyzer

Your eyes and the MAGIC TUBE see all, know all, react as a unit!

Write for Descriptive Literature



SOLAR MFG. CORP., 509-511 Broadway New York, N. Y.

kitchen now. Mrs. Jones hasn't said she would buy it yet—but the fact still remains that we've gone out to look for a suitable spot! We make some casual remark about taking care of the outlet, just like we consider the sale already made, and then go right back to where we were:

"Forget all that, Mrs. Jones. Think of only one thing. How much is it going to *cost* you. Well, you have the figures. And they're right, aren't they? Don't forget, I took the worst of it on *all* those figures, and yet this box will cost you, over and above what you'd pay anyway—and for unsatisfactory, inconvenient refrigeration at that—approximately \$1.00 a month. Just think, about 25¢ a week.

"And that's only *while* you're paying for it, don't forget. After all, you're not going to pay on it forever, like you do with the ice man. In thirty months it'll be paid for.

"And what will you have *then*? You'll have good refrigeration, perfect, convenient refrigeration—for nothing. (We say "for nothing" deliberately, so she'll remind us of the cost of operation.)

Operation Cost Patter

"Cost of operation? True, Mrs. Jones, very true. You'll still have the cost of operation. But that's only a *fraction* of what your *ice bill* would be—your year-around ice bill—and a very small fraction at that, about a third.

"And don't forget—you'll *still* be saving all that money on your food bill. So you're right; the cost of operation won't be "nothing". It'll be *less* than nothing—compared to what you *would* spend. You'll be paying about 75¢ a month, and paying it for something you *do* want . . . where before you were paying about \$5.75 a month—\$2.25 for ice, the year around, and losing about \$3.50 a month on food—and paying it for something you *don't* want.

"Is that right, Mrs. Jones?" (Make her *admit* it. Don't tell her all this and then just let her stand there in a fog, looking for some resistance that she can't find.)

We decide that the box will look very nice right where the old ice box is now, and then return to the living room. If we can close the sale right here, or at least get Mrs. Jones' signature on the contract,

of course we do it. But the chances are that we have got to see Mr. Jones. So we proceed to get a line on the husband.

Hitting the Husband

If it appears that, in spite of the fact that we must see the husband, the lady is pretty much boss of the household (which is quite often the case!), then we don't worry so much on that score. But if it seems otherwise, then we say something like this:

"Well, I'm glad I've convinced

you, anyway, Mrs. Jones. But if, as you say, it's entirely up to your husband, then I'll naturally have to convince him, too. What's the best time to talk to him? You know—when he's in a listening mood. I see. You have dinner at six? Then about seven o'clock would be a good time, wouldn't it?"

Then, finally, there is one more thing we can say. But whether or not we should say it, depends entirely upon Mrs. Jones. It is very important that we *do* say it, if the

(Continued on page 72)

THE PORTABLE LAB

that gives you

EVERYTHING!

SUPREME

504 TUBE and SET

TESTER



» » » QUICK FACTS « « «

- Complete, modern tube tester and set tester with total of 31 ranges and functions.
- "Arrow-Way" tube testing using fast roller chart. Set controls from left to right—just follow the arrows.
- Correctly checks all tubes—including "7," "14," "35," "50," "S" (single end tubes) series, octals, octals, non-octals, "G," "MG," "M," "GT" types, gaseous rectifiers, magic eyes, ballast tubes, pilot lights.
- Tests tubes 7 ways (1) open filaments, (2) "hot" leakage cathode test, (3) super-sensitive "hot" anode leakage test, (4) shorts, (5) opens, (6) overall quality, (7) separate section and plate quality test. Only a good tube will pass.
- Tests made at proper applied anode voltages and rated load for all tube types.
- Only six sockets required for all present and future tubes. No additional instructions necessary on the tube chart. You can't place a tube in the wrong socket.
- Patented SUPREME "double floating" Filament Return Selector Push Button System banishes obsolescence. Let filament positions on future tubes change to any possible arrangement—to take care of such changes all you do is PRESS A BUTTON.
- Tapped transformer secondary supplies all CORRECT heater and filament voltages.
- "Speed-Way" push button multimeter circuit. Two rows of push buttons control 31 basic ranges and functions.
- 0.1 to 2500 D.C. Volts. 7 ranges of 0/5/25/100/250/500/1000/2500.
- 0.1 to 1400 A.C. Volts. 5 ranges of 0/5/10/50/250/1000.
- 10 Microamperes to 10 Amperes. 7 ranges of 0/500 microamperes/2.5/10/50/250 milliamperes/1/10 amperes D.C.

- 0.1 to 1000 Output Volts. 5 ranges of 0/5/10/50/250/1000.
- 0.1 to 20 Megohms. 3.5 Ohm Center Scale. 5 ranges of 0/200/4M/20M/2 Meg/20 Meg. Self-contained power supply.
- All electrostatic capacitors checked for leakage up to 20 megohms on meter.
- All electrolytics including high voltage filter capacitors and low voltage—high capacity bypass capacitors, checked at working voltages.
- 7 individual working voltages of 450, 300, 250, 200, 100, 50 and 25 volts.
- Settings are given for each capacity and working voltage on roller chart and tests made on a "Good Capacitor—Bad Capacitor" English reading scale.
- All ranges except D.C. 2500 volt and 10 amps. operate from but one set of pin jacks.
- New "Permi-grad" temperature compensated A.C. voltmeter circuit with full rectifier protection. Rectifier guaranteed with instrument.
- 4" x 4 1/4" 500 microampere meter built by Westinghouse—oversize solid forged magnet with welded pole pieces built to United States Navy standards—a life-time meter.
- All multimeter ranges factory calibrated to within 2% on D.C. and 3% on A.C.
- Individually, specially selected and aged ceramic resistors used for all voltmeter ranges. Wire wound resistors in all current ranges.
- May be purchased on easy payments—just a few cents a day, no more than the cost of your cigarettes.

CASH PRICE \$55.50

Installation terms \$5.09 cash and 11 payments of \$5.09.

SUPREME

SUPREME INSTRUMENTS CORP.
GREENWOOD, MISSISSIPPI, U. S. A.

EXPORT DEPT. Associated Exporters Co., 145 W. 40th Street, New York
Cable Address: LOPREP, N. Y.

MAIL COUPON TODAY!

SUPREME INSTRUMENTS CORP., Dept. R-2
Greenwood, Miss.
Please RUSH me your newest information on SUPREME 504 and 6 other brand new SUPREME instruments.

Name: _____
Address: _____
City: _____ State: _____

SHOP-TO-SHOP SHOPPER— Unless some customers are tagged with a minimum service charge they will waste servicemen's time no end

THREE STRIKES



on the Serviceman's Pocketbook

By **JOE MARTY**

*Executive Secretary
Radio Servicemen of America, Inc.*

COLONEL BOLIVAR TRASK once told me how he cured his girl friend of flirting. When her behavior at a night club was particularly bad, he murmured to her in a soothing voice, "Honey, look at the clock and tell me what time it is."

"It's ten minutes until twelve," she replied. "Why do you ask?"

"Well, Baby, I just wanted you to realize that in ten minutes I am going to bust you right on your snoot if you don't stop flirting with that guy behind my back."

Having local jobbers carry on flirtations by selling retail at wholesale is one of those things that annoys a serviceman no end.

STRIKE 1 . . Wholesale selling

Most servicemen feel that they are "going steady" with their jobbers. Their regular purchase of parts, week in and week out, gives the jobber six to ten times turnover, the lifeblood of his business. Why then, should jobbers indulge in funny business with retail customers? Servicemen wonder.

Oh, I'll admit that the jobber can pick up some juicy crumbs of business when he sells at 40 off to retail consumers. He gets cash on the nail, and his 60 off original cost still leaves him a 20 per cent profit. But you can imagine how it burns the serviceman up to have a new set owner call up and say, "Won't you come out and hook up our new radio, we just bought it wholesale."

Strike one on the serviceman's pocketbook is wholesale selling. It takes the heart out of the fellow on the retail firing line. It can be stopped and I am going to tell you how.

The average American town has about 50,000 population. We'll call the one I have in mind Waddington, after my stenographer's chewing gum. There are three jobbers in that town:

No. 1 gets 90 per cent of his volume from parts and 10 per cent from radios.

No. 2 gets 55 per cent of his business from sets and 45 per cent on parts.

No. 3 gets 70 per cent of his volume from wholesale repair service and 30 per cent on parts.

As our story begins, all of these fellows were selling over the counter to anybody who had the cash in hand. Dealers and servicemen going over to make a purchase would encounter school teachers, bankers, all kind of folk there shopping away, taking stuff home. It got so that virtually every all-cash deal in town was on a wholesale basis.

The twenty-one service men in Waddington felt as if they were licked. Five or six of them did contract work for dealers, one or two worked for dealers and eleven of them carried a stock and were combination radio dealers and servicemen.

A stack of part catalogs that they all received gave them a cue. One evening they held a pow wow with three jobbers, on invitation.

Said the spokesman: "The twenty-one men present are giving

the jobbers in this city 98 per cent of their parts business. On the other hand, the jobbers in this town are cutting us out of half of our sales by selling on a wholesale basis. We don't think it's fair. How would you like the twenty-one servicemen present to switch all of their parts orders to these wholesale catalog people—to shoot them out of town? You, jobber No. 1 would lose 90 per cent of your volume; you, jobber No. 2 would lose 35 per cent and you, jobber No. 3 would lose 30 per cent of your business if this happened. We believe in the good old adage, 'You scratch my back and I'll scratch your back.' Have I gotten over my idea?"

That ended wholesale selling in Waddington. There is still a little that goes on to friends, but, by having an association, ready to act together, these servicemen got response that not one of them could have claimed alone.

STRIKE 2 . . Amateurs

Strike No. 2 on the serviceman is the amateur who cuts into his business.

And, on any blue Monday when calls don't come rolling in, you can hear somebody in the shop holler, "Drat those amateurs. They are wrecking our business for us. Not a telephone call this morning."

As secretary of the Radio Servicemen of America, I've heard that squawk all over the country. In every case where I have time, I always ask what the names of the amateurs are. I call on them and sit down for a chat. In every case Mr. Amateur has always let the same cat out of the bag—they fixed a radio for a relative now and then—or for a fifty cent fee or something like that. They were true screw-driver mechanics and while

they might have a volt-meter and an ammeter, they had no tube tester or anything remotely approaching modern service equipment, nothing else. Not one of them fixed more than one or two radios a month.

What's ten radios a year? I say amateur competition is the bunk anywhere you go, and the quicker servicemen lay the ghost of that idea, the better off they will be. You realize in any work that is done for relatives you are behind the 8-ball, because you cannot collect. On the other type of 50¢ customers that the amateur gets, I say to you—you are much better off without them—and the loss is not a liability but an asset.

Strike 2 is really a mental hazard servicemen should get out of their systems.

STRIKE 3 . . Shopper Psychology

Strike No. 3 that gets called on the serviceman is from old Mrs. Fanny Q. Public herself. I am thinking of a situation that gives more servicemen an inferiority complex than anything I have ever barged into.

The average woman shopper, accustomed to battling over a thousand bargain tables, can take the serviceman apart as deftly as she carves a chicken. Just stick around any work bench if you want to see how the trick is done, and I assure you that the serviceman is entirely to blame, because he operates on a basis of "How much can the customer pay?" Very wrong, I assure you.

A typical situation is the woman who brings into the shop a table radio which is on the bum. "I want to know how much it will cost to have it fixed?" she asks.

Mr. Serviceman fiddles away a half hour of time checking it over

and then reports; "You have an eight mike condenser that's bad and there is a 25Z5 tube that needs replacing. It will cost you \$4.75 to fix it up."

"What?" shrieks the housewife. "Why that radio only cost us \$7.95. I wouldn't think of spending that much."

So, taking her radio under her arm out she waltzes, leaving Mr. Serviceman to write off a half-hour time as wasted. Furthermore, Mrs. Shopper gives the boys a run around in half a dozen other places.

I've seen a service man handle a woman like that by saying, "Well, Madam, in its present shape your radio isn't good to anybody. If you can't afford to pay \$4.75 to fix up a \$7.95 radio I'll make you a proposition—I'll give you \$2 for it. It's no good to you as it is, and I can repair it and get something for it."

That crack usually gets the customer to thinking that if the set is worth \$2 to the serviceman, it is undoubtedly worth a great deal more than that to her, and before long she loosens up and pays the \$4.75 service charge.

But the only smart thing to do with a shopper is to have a sign in the place, prominently displayed, that announces that a 50¢ or a dollar examination service charge is made. Any shopper will quickly realize that if she runs around the neighborhood with her broken radio, each place she stops will simply add more to the ultimate cost of having it repaired. There is nothing better than a sign to cut down shopping for repairs.

There is one other way that shoppers get servicemen across the barrel. In a lot of cases a man is called into the house to repair a radio. The trouble is very obvious and easy to spot. Say an 80 tube needs to be replaced. In no time at all Mr. Serviceman has the radio perking.

"What is your bill?" asks the lady of the house.

"Here it is—\$1.50 for service call and a new tube," he replied.

"What?" again yelps our heroine, "Why you haven't been in this house five minutes. What do you mean by asking \$1.50 for five minutes of your time? You servicemen must be getting rich."

(Continued on page 76)

HOW DO YOU MAKE OUT YOUR BILLS?

Here's a **BAD** one:

Repair to radio as per estimate.....\$4.75
(One condenser\$4.00) (Labor..... .75)

Here's a **GOOD** one:

Repair to radio as per estimate.....\$4.75
(One condenser\$1.75) (Labor.....3.00)

- | | |
|------------------------|-------------------------|
| 1. Remove from cabinet | 4. Clean volume control |
| 2. Install condenser | 5. Adjust speaker |
| 3. Clean chassis | 6. Beliver and install |

MAJOR points of technical interest in 1939 auto radios are the widespread use of automatic tuning and the introduction of loctal tubes into this field. Automatic tuning, although not new in auto sets, is receiving greater attention than last year. Presetting pushbuttons is another chore for the serviceman. Excessive vibration and severe temperature changes probably will produce service calls on some of these systems. Thus the auto-radio-man should be familiar with each tuning method.

Types of Tuning Systems

Similar to home sets, automatic tuning in the new auto radios may be divided into three classes: Mechanical types which rotate the gang condenser by cams actuated in turn by pushbuttons; motor driven types driving the gang and provided with mechanical or electrical stops; and selector switches operating in conjunction with trimmers or permeability tuned circuits or both.

Fig. 1 shows the schematic of a typical motor driven selector switch as used in the Philco 937. Notice the three gang switch sections at the lower left. The left section selects either of 5 trimmer capacities tuning

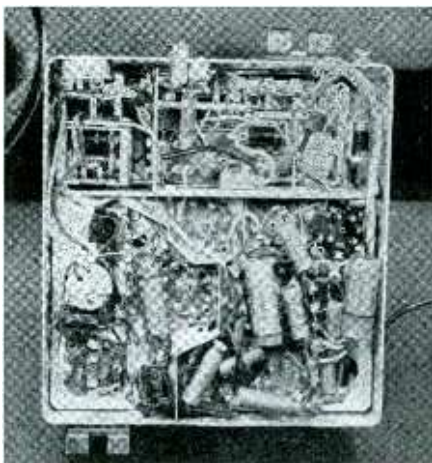

FIG. 2. Construction and layout of the circuit shown in Fig. 1. Tuning motor and reduction gear are visible in the upper left compartment. Upper right compartment houses gang switch (right) and trimmers (upper center)

the input to the 7A7 r.f. stage. The middle section selects separate permeability tuned oscillator circuits. The section farthest to the right is the motor timing switch. When any pushbutton is pressed, this latter section holds the motor relay closed until the opening on the rotor arm is opposite the contact corresponding to that pushbutton. When this position is reached the motor circuit opens,

Installing 1939 Auto Radios

By **C. A. NUEBLING**

Technical Editor

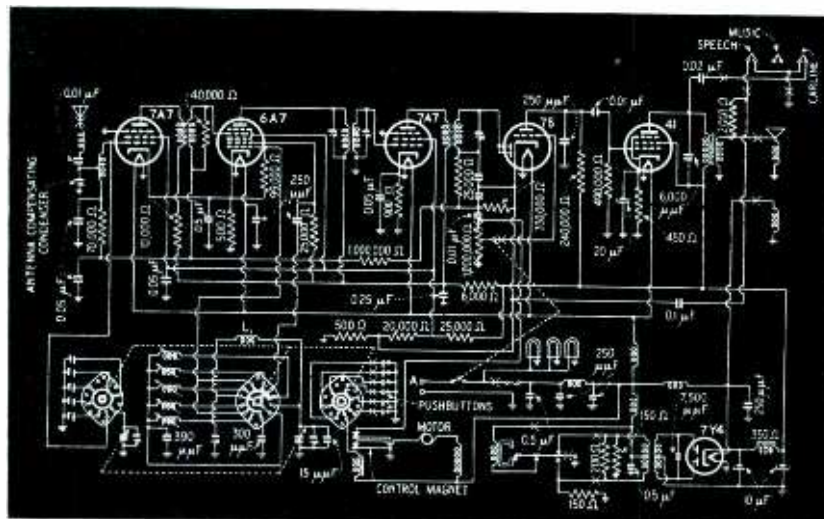

FIG. 1. Selector type automatic tuning as used in a typical set is shown at the lower left. 7A7 tubes are used as r.f. and i.f. amplifiers.

stalling the motor. In the meantime the other two gangs have substituted a new capacity or inductance in the r.f. and oscillator circuits respectively.

It should be noted that the input to the converter stage is not tuned since this is an iron core close-coupled transformer. By this method one set of pretuned circuits are saved, and at the same time images are prevented by the r.f. stage.

Fig. 2 shows the arrangement of parts for the schematic of Fig. 1. Alignment of stations in this receiver is the same as any other capacity or inductance tuned system. With the set switched to automatic tuning, push any button and tune the corresponding oscillator adjusting screw to the desired station. Then peak the corresponding r.f. trimmer for maximum signal. Each button has a definite tuning range and does not cover the whole band so that plotting of stations is necessary.

Mechanical Types

Alignment of most mechanical systems is fundamentally the same. Fig. 3 illustrates the RCA 9M1. To set up the stations, remove the pushbutton knobs, exposing the locking screws

which should be unscrewed several turns. Then, using the manual tuning knob, tune in the desired station. Hold the manual tuning knob and press the first knob as far as it will go. Take care that this doesn't detune the station. Release the button slowly; tighten the locking screw and replace the knob. Repeat this process for each button.

A motor driven gang condenser and a mechanical selector system is used in Motorola models 949, 969, and 15F. Construction of this is illustrated in Fig. 4. When a button is

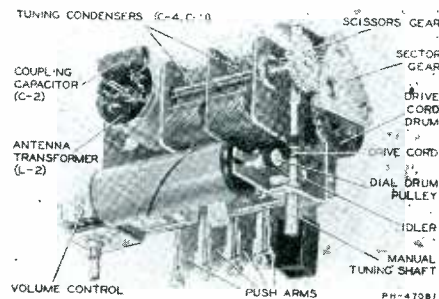

FIG. 3. Mechanical automatic tuner. Pushbuttons operate cams, turning sector gear, in turn driving gang condenser

pressed the motor turns the gang and latch rings slowly. Simultaneously the latch bar magnet is energized, pressing the latch bar against the latch ring. The motor, gang, and latch ring rotate until the latch bar is seated in the notch on the latch ring. This corresponds to a preset position of the gang condenser.

To set stations on these receivers it is recommended that the adjustments be made manually rather than permit the tuning motor to run. To do this, loosen the locking screw on the latch rings 4 or 5 turns. Turn the gang condenser all the way in (535 kc.). Press the first button lightly, just far enough to energize the magnet; turn the gang manually all the way to the high frequency end then back to the low end. This action positions the latch ring so that notch will contact the latch bar. Still pressing the button, tune in the station to be set on that button. Set the remaining buttons in a similar fashion. Then tighten the locking screw securely. Do not hold the tuning knob while locking the settings but allow the mechanism to turn to its natural stop.

Other Circuits

Following the trend of pushbutton operation, some manufacturers have designed their tone control system around buttons. This is illustrated at

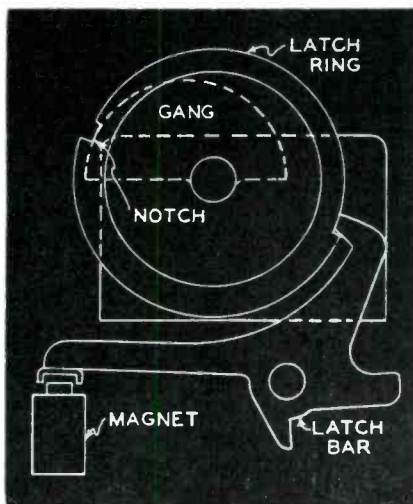

FIG. 4. Motor driven mechanical selector system. Position of latch ring notch determines setting of gang

the upper right corner of Fig. 1. Pushing the "music" button allows maximum fidelity. The "speech" button permits only a medium band of frequencies to pass, whereas "Carline" removes all the highs to effectively reduce hash caused by noisy electrical equipment.

With regard to the use of suppressors, most manufacturers recommend a single distributor unit. Only in



From The Successful Servicing Laboratories of JOHN F. RIDER

A Really New Instrument. New in Design—New in Performance. Unequaled by any existing piece of equipment now available to the servicing field!—A device as sensational in performance as The Rider Chanalyst! Announcement of this new Rider instrument will be made in next month's magazines. It will headline the news—it will be talked about wherever two servicemen get together—don't miss it.

This New Device WILL NOT Take the Place or Do the Work of The Rider CHANALYST

So—if you do not already own a Chanalyst get the facts on this proven instrument which will cut your trouble-shooting time to an absolute minimum. Find out how simple and easy it is to use the Chanalyst for the location of defects in receivers of all types and makes. Send for the new illustrated 80 page (8½ x 11") book. Get the facts which will enable you to go to your jobbers and demonstrate the Chanalyst to yourself. Send the coupon at right NOW!

Don't buy any instrument until you have all the facts. Send coupon for complete story on

The RIDER CHANALYST

Service Instruments, Inc.
408 Fourth Ave., New York City
Enclosed find 25 cents (in stamps or coin) for the 80-page book completely explaining the Rider Chanalyst and True Dynamic Testing.

Name.....
Address.....

SERVICE INSTRUMENTS, INC.

404 Fourth Avenue, New York City
Foreign Division—147 W. 45th Street, N. Y., Cobles—"Servicin"

CIRCUITS

Diversity Coupler

Giving the advantages of dual diversity reception, a device by Guthman may be attached to any receiver.

The principle purpose of the unit is to eliminate fading. This is accomplished by using two antennas; one horizontal, the other vertical. It is a known fact that two separate antennas in different planes seldom have similar voltages induced in them. Usually when these antennas are separated by a few hundred feet, the voltage in one may fade down to zero while the other will be increasing to a maximum.

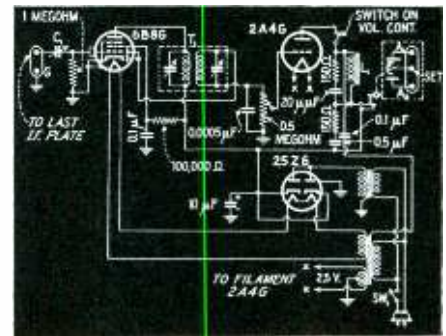

Referring to the diagram, the 6B8 tube is an auxiliary i.f. amplifier and is coupled to the plate of the last i.f. stage in the receiver through C1. Any signal in the receiver is further amplified by this tube and rectified by the diodes of the 6B8. The voltage thus rectified feeds the grid of the 2A4G, a small thyratron. Plate current flows in the thyratron after the rectified voltage impressed on its grid has reached a certain value. A potentiometer in the grid circuit controls this value.

When plate current flows in the 2A4G it operates a relay or magnetic motor. The motor may be likened to a stepping relay, in which pulses of a relay armature turn a ratchet, and in turn, a shaft. On the shaft is a small variable condenser with 2 stators and one rotor. Turning the rotor in one position engages it with one stator and disengages with the other. Five positions of the rotor are available.

Returning to the circuit, the horizontal antenna is connected to one stator, the vertical to the other. The antenna post of the set is connected to the rotor. Thus, either the vertical or horizontal antenna may be capacity coupled to the receiver by changing the position of the rotor.

Tracing through the entire circuit then: with a signal in the receiver and reception taking place on the horizontal antenna; a fade in the signal produces a change in voltage

obstinate cases will suppressors on all plugs be necessary. In the RCA sets an antenna filter is built in. This consists of an inductance in conjunction with a small capacity in series with the antenna to form a low pass filter. This is mounted at the antenna input to the set. Since most ignition and vibrator interference is of a high frequency nature, it is bypassed by this circuit; leaving the broadcast signals unaffected.

Tubes

Loctal tubes are used exclusively in some sets, others use some loctals and some glass or metal, or a combination of the latter two. All loctals are single-ended and employ 7 volt heaters. However they may be operated between 6.3 and 7 volts, so no changes in filament power circuits will be found. (There are other loctals with

35 volt filaments but these will not be discussed here).

Six types will be commonly used in the new sets. The 7A6 is a duodiode similar to a 6H6 and employs a .15 ampere filament. The 7A7, comparable to the 6K7 draws .32 ampere filament power. An octode converter, the 7A8 draws .16 ampere. Type 7B7, a triple grid amplifier similar to the 6S7 also draws .16 ampere. A duodiode triode, type 7C6 likewise draws .16 ampere. The 7Y4, a full-wave rectifier draws .53 ampere. Some interesting possibilities are offered by these tubes; full characteristic data will be given next month.

Antennas

The antenna recommended by the manufacturer in the majority of cases is the cowl or whip type. The cut-away drawing in Fig. 5 shows a new idea for increasing pickup. The antenna is a standard type mounted on the side of the cowl and insulated from it. The top insulator serves as a lead-through connecting the antenna to the shielded antenna lead. Notice the booster coil in series with the antenna and antenna lead. By so doing the antenna is "loaded". This effectively increases the impedance of the antenna proper, thereby increasing the voltage induced into it.

Several manufacturers have a tapped antenna coil to allow use of either high or low capacity antennas. Others use a small capacity which is inserted in series with high capacity antennas. Still others tune out any capacity reactance with an antenna trimmer.

As an aid to installation, the chart in Fig. 6 has been prepared to familiarize servicemen with common noise points in the average car. Other points may be troublesome in some installations, however, the points indicated will usually be found to be the chief offenders.

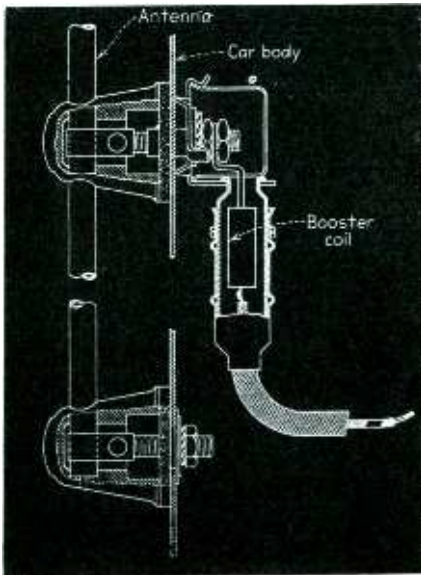

FIG. 5. Low capacity cowl antenna with booster coil added to increase sensitivity

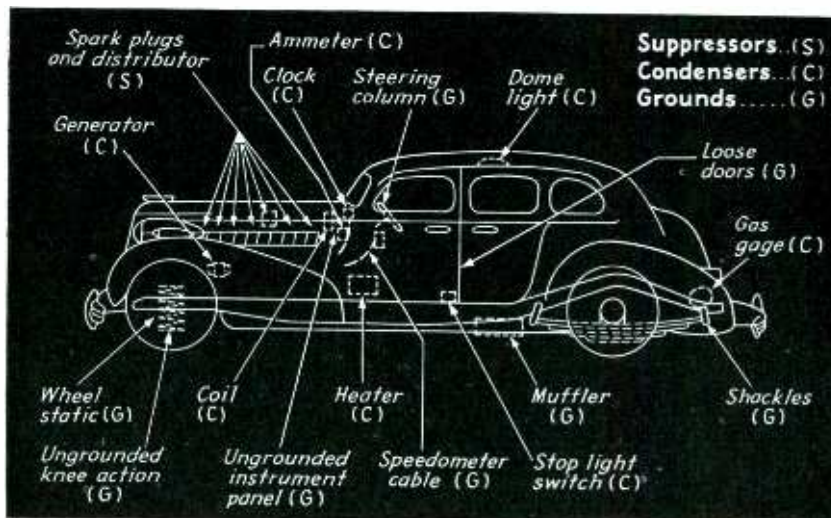
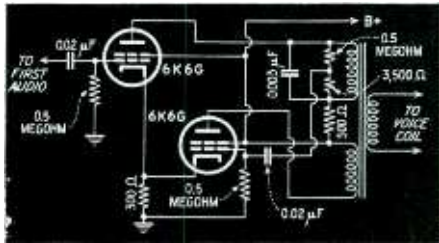

Fig. 6. Common causes of objectionable noise in auto radios and their remedy

in the 6B8 and consequently on the 2A4G grid. This causes plate current to flow in the 2A4G, actuating the magnetic motor which operates until the strongest signal position of the dual condenser is found.



Simplified Inverter

Many types of phase inverters have been shown in the past; a simple version, shown herewith, is used in the Truetone D920.

The upper 6K6G couples to the first audio stage in the usual manner for a single-ended stage. The plate of this tube, however, feeds into one section of a split-primary output transformer. Audio voltage from the plate circuit develops across this winding and also across the shunt voltage divider network. The value of the resistors in the divider network is such that a voltage equal but out of phase with that generated by the first audio stage is applied to the grid of the lower 6K6G. Audio voltage developed by this tube supplies the lower half of the primary winding. Since this voltage must pass through the tube its phase is again reversed. It is now in-phase with the original voltage from the first audio stage and out of phase with the plate circuit of the upper 6K6G. The latter condition fulfills the proper relation for pushpull tubes.

Attend the National Radio Parts Trade Show

1939 **JUNE** 1939

WED	THU	FRI	SAT
14	15	16	17

OPEN ONLY to Jobbers, Manufacturers, Manufacturers' Agents, and Manufacturers' Engineers.

OPEN to Servicemen, Amateurs, Retailers, Students and others.

Stevens Hotel, Chicago

14 WATT or 35 WATT or any POWER SOUND SYSTEM *Select the ECONOMICAL • DEPENDABLE...*



● Portable System Model PX-714 includes one Model 1236 Crystal Microphone, mounted on a banquet stand, complete with 25 feet of rubber covered shielded cable and plug; one No. 714 Amplifier, two No. 3810 10" P. M. Speakers with 25 foot cables and polarized plugs. All is contained in one moderate sized carrying case.

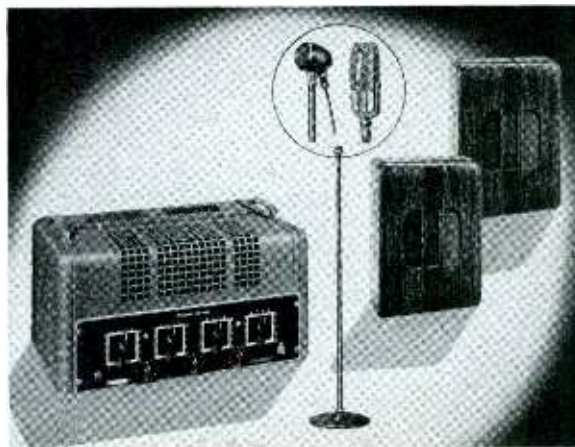

● 35-Watt Model FD-35 includes Model 4L35 12-tube, 35-watt amplifier, remote control with 25' of flexible cable, 1245 Dynamic Microphone with 25' of shielded rubber covered cable and plug, one No. 1122 microphone stand, 2 Model 3813 speakers, 2 Model 2824 wall baffles.

★ Webster-Chicago manufactures a complete line of sound equipment and accessories.

Ask Your Jobber or Write
For 14 Watts . . . 35 watts . . . or any size
Sound System . . .
The Natural Choice is

WEBSTER-CHICAGO
5622 Bloomingdale Ave., Chicago, Illinois

Webster-Chicago

14 WATT SYSTEM

Model PX-714

- Underwriters' Laboratories Approved
- High Gain (123 D.B. 14 Watt Beam Output Type Amplifier)
- Improved Multi-Stage Inverse Feedback Circuit
- Two Individual Electronic Input Circuits
- Variable Output Connections for Additional Speakers
- For Portable or Permanent Installations

35 WATT SYSTEM

Model FD-35

- High Speed Expander
- Multi-Stage Degeneration
- 4-Input Mixing Circuits
- Dual Tone Compensation
- Underwriters' Laboratories Approved
- Remote Control
- For Permanent Installations

... Economically Priced

Manufactured under license arrangements with Electrical Research Products, Inc., subsidiary of Western Electric Co., Inc., and American Telephone and Telegraph Co.

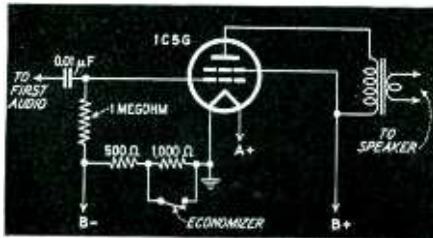

Economizer for Battery Sets

Advent of 1.4 volt tubes brings small battery portables increased popularity. With this comes the Economizer Circuit contained in Howards model 4BT. The action of this circuit is based on the following statement: When listening to a receiver either full output is desired, or, as is more often the case, just a moderate listening volume.

Either of these conditions may be satisfied in a standard set simply by turning the volume control. However this does not reduce the power drawn by the set, it only reduces the efficiency. Since efficiency is an important factor in battery sets the Economizer shown here should prove effective.

The Economizer circuit takes place only in the audio output stage since the power consumed here is greatest. Normally, without the Economizer (with the switch closed) the set provides maximum output and maximum power drain. Notice that bias for the 1C5G is obtained through a drop in the 500 ohm resistor connected from B minus to ground. With the Economizer in operation, (switch open) an additional 1000 ohms is added to the bias network, increasing the voltage drop and bias on the 1C5G, simultaneously reducing plate current. Operating characteristics of the other tubes in the receiver remains approximately the same. However their plate current is small compared to the output tube.

As an indication of how the system works; with a plate voltage of 90 volts and a total plate current of 12 milliamperes, the normal output is 360 milliwatts. With the Economizer in operation, total plate current is reduced to 7 milliamperes for an output of 180 milliwatts.

Signal Strength Indicator

For communication purposes and experimental short wave use a signal strength indicator is a useful asset to any receiver. The indicator circuit

shown here was taken from Hammarlunds new HQ-120-X receiver; operation of the circuit is as follows:

Without a signal passing through the 6S7 i.f. stage and with the manual gain control turned off, the plate current of this tube is at a steady value. Since plate and screen current flow through the cathode circuit a voltage drop occurs through the 830 ohms in series with the cathode to ground. The drop through the lower 50 and 80 ohm resistors is enough to bias the

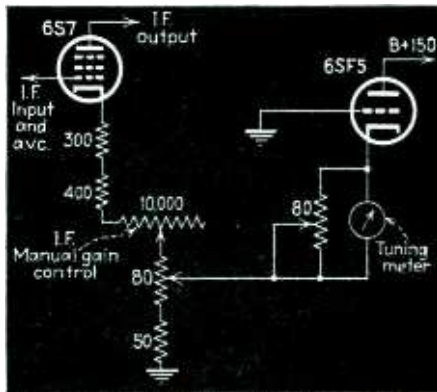

cathode of the 6SF5 sufficiently positive to cut off its plate current. Under these conditions there is no current flow in the 6SF5, consequently the meter in its cathode circuit rests at zero.

If a signal is tuned in, it passes through the 6S7, is rectified, part of the voltage returning through the a.v.c. network to increase bias and reduce i.f. gain and plate current. Reduction of plate current produces a corresponding reduction in the voltage drop across the cathode resistor network. This likewise reduces the voltage available at the 6SF5 cathode and plate current flows in this tube, operating the meter. The amount of meter movement is dependent on the amount of a.v.c. voltage available; consequently, the meter is an accurate signal strength device.

Remote Record Player

The record player by Philco shown herewith, incorporates some novel features. Among these is a switch in the tone arm which starts the turntable when moved to the outer edge of a record. The same switch stops the turntable when the arm is near the center of the disc. In the pickup head, near the needle, is a small pilot light which makes placing of the needle on the record easy.

The oscillator circuit, a 6A7, is of

the Hartley type. The tuned circuit consists of a single tapped coil. The lower section of the coil serves as the plate circuit, the upper section as the grid or tickler circuit. A 110 mmf. condenser couples the upper section to the number 4 grid.

A crystal pickup feeds into the number one grid, a volume control in this circuit is conspicuous by its absence. This is of little consequence to fidelity since with maximum pickup output, the plate voltage on the tube adjusted so that overmodulation of the oscillator cannot occur. Thus, good reproduction may be had. Volume can be controlled at the receiver.

There are no radiation leads or antenna posts on the unit. A radiation system is built within the box and requires no external wires up to 60 feet from the receiver. The inclosed radiator connects to the plate end of the tuned circuit.

When shipped, the instrument is adjusted to 1500 kc. In some instances there may be a local station on this frequency which necessitates shifting the R.P. frequency higher or lower. Adjustment may be had between 1450 and 1750 kc., any clear channel is satisfactory.

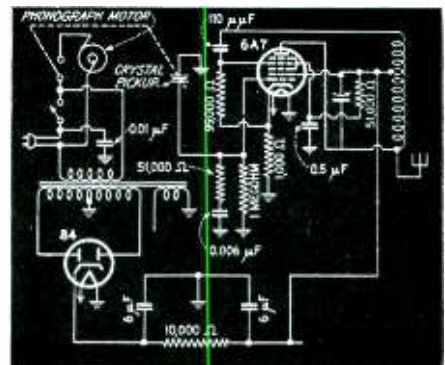

Low Drift Trimmer

Used in Howards push-button tuners, a slider type trimmer claims greater stability over compression types.

As illustrated, a set of stator plates, separated by a dielectric, are made to accommodate the moving plates which are pushed in between the dielectric.

The control action of the moving plates is accomplished by an arm which engages the adjusting screw. A tension spring reduces backlash in the thread to a minimum.





New AC-DC Tubes

No sooner do we finish a new tube chart when more new types are announced. Nine tubes by Arcturus, especially designed for ac-dc operation, offer interesting possibilities heretofore unobtainable.

Filament current on all types is 150 milliamperes; filament voltages however are 12, 25, 35 and 50 volts. These voltage ratings permit operation with little or no ballast resistance, increasing efficiency and reducing heat inside the chassis.

The tubes are smaller than the average

types as can be seen from the illustration. A standard octal base is used, however, a metal shield completely encircles the bottom of the bulb and base. This greatly aids shielding.

The line includes a pentagrid converter (12A8GT); a sharp cut-off r.f. pentode (12J7GT); a remote cut-off r.f. pentode (12K7GT); a triode (12F5GT); a double-diode-triode (12Q7GT); two types of beam output tubes (35L6 and 50L6); a half-wave rectifier (35Z4GT); and a multi-purpose rectifier (25X6GT).

In addition to ac-dc uses, the 12 volt types offer many possibilities for use on aircraft, boats and farms where the supply voltage is 12 volts.

Simplified Frequency Meter

Relying on standard broadcast stations for accurate calibration, the frequency meter circuit by Guthman, illustrated here, offers many possibilities for the experimenter and critical serviceman.

The unit consists fundamentally of a 43 electron-coupled oscillator with its main tuning condenser accurately calibrated on a large metal dial. These

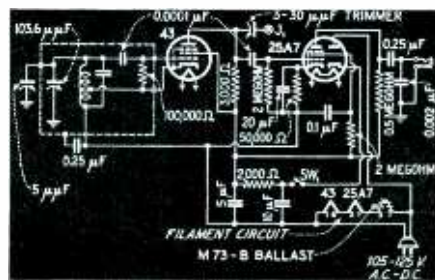

calibrations are arranged in six bands, each band covering 324 degrees of the dial. Following the oscillator is a detector—amplifier the purpose of which will be described later. In addition, a half-wave rectifier supplies plate voltage to the unit.

In operation, with filament and plate voltage applied, choose some local broadcasting station between 850 and 1030 kc which you know is operating. Connect a three-foot lead to J1 and couple this to the receiver's leadin by twisting a few turns around the lead. Tune the frequency meter to twice the frequency of the B.C. station. Adjust the small 5 mmf condenser shunted across the main tuning condenser until zero beat is heard in the headphones plugged in the jack shown at the right. Care should be taken to get this zero beat accurately set. The meter is now

Instruments that set their OWN standards —

● The Simpson record is one more proof that a higher standard does not have to wait long for recognition. Unknown before August 1936, Simpson equipment enters 1939 at the head of the instrument procession in the opinion of hundreds of servicemen who recognize the finer things in radio testing equipment.

See these modern instruments. Examine them critically. Measure them by any standard — design, workmanship, range, performance, beauty, and above all sheer quality in solid terms of dollar value. One careful inspection of any Simpson Instrument will be your final reason for standardizing on this versatile line for all of your testing needs.

A few of the many Simpson Instruments are briefly described here — instruments that can make 1939 a happy servicing year for you. Ask for latest bulletins.

Order from your jobber

SIMPSON

INSTRUMENTS THAT STAY ACCURATE

SIMPSON ELECTRIC COMPANY, 5204 Kinzie St., Chicago



Model 440 "Test Master"

● An all service tube and set tester. Double-filament switching; screen fluorescence and angle test; hot cathode leakage test; high sensitivity neon short-check; noise test; percentage scales; "good" and "bad" scales. As set tester has six A.C. and D.C. voltage ranges; resistance ranges from 1 ohm to 100 megohms; four milliamp ranges; six decibel ranges; 0.15 amp. scale; neon leakage test, noise test, etc.

\$59.00

Your price



Model 333 Tube Tester

● Small and light in weight. Tests all tubes, including new Loctal and other recently developed types. Has double filament switching.

\$26.50

Your price



Model 230

● The smallest A.C.-D.C. instrument on the market, yet it contains a sufficient number of ranges for the experienced man to perform a complete servicing job.

\$14.25

Your price

calibrated, however if a high degree of stability is required it should be allowed to run for six hours before calibration.

While listening to a stations in the 160, 80, 40, 20, 10, or 5 meter bands, tune the large F.M. dial until a beat with the received station is heard. Knowing the band on which the receiver is operating, find this band on the F.M. dial and the exact frequency of the received station will be found.

Accuracy of the unit is dependent on the accuracy of the B.C. station. All B.C. stations must maintain their frequency within 50 cycles. Most stations have an accuracy better than 10 cycles. The accuracy of the frequency meter will be plus or minus this figure times the number of megacycles on which the measurement is made.

High Fidelity Receiver

R.F. tuner circuits in Pacents high fidelity receiver are separate from the audio amplifier and power supply. A 25 foot flat strap-type cable connects the tuner unit, shown at upper left in the schematic, to the associated equipment in a closet or some inconspicuous point. In this manner it is possible to have a high fidelity receiver which takes up no more room space than the smaller midgets. Tuner dimensions are $8\frac{1}{2} \times 4\frac{1}{2} \times 3\frac{1}{2}$ inches.

A 6K7 first r.f. stage couples to a second 6K7 through a bandpass transformer. This stage, in turn, feeds one plate of the 6R7 diode-triode; the second diode plate supplies avc. The antenna is fed to the tuner through a low impedance winding on the first r.f. input coil. One side of this winding goes to ground; the other side carries through the cable to a tap on the coil

at the lower left of the amplifier where it is transformed to high impedance for normal antenna and ground connection.

Directly above the 6R7 is the volume control and phono-switch. From this point on, the remainder of the diagram is purely audio circuits.

Starting from the output tubes (right) and working forward, the 6A3* supply 10 watts of undistorted audio power. These are driven by the twin elements of a 6C8, one section of which also serves as a phase inverter. This brings us to the 4 triodes arranged vertically to the left of the amplifier schematic.

The topmost triode of this group amplifies impulses from the phono pickup, and at the same time transforms this

voltage to a lower impedance source so that it may be coupled to the triode section of the 6R7 through the cable with little hum pickup. The three lower triode sections have their plates in parallel and coupled to the driver. The grids of two of these however, are independently controlled by the potentiometers to the right of the 6R7. The lower triode gives normal frequency response. The two middle sections control low and high frequency compensation respectively by virtue of filters in their grid circuits.

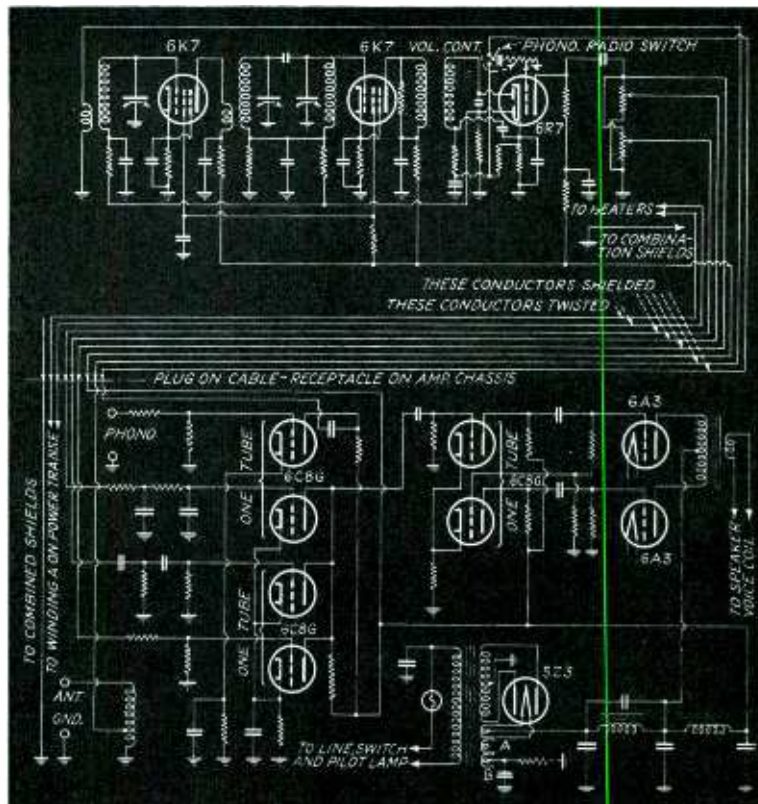

ATR Announces NEW PRODUCTS! MODELS! PRICES!

- Shaverpacks
- Low Power Inverters
- Radio Inverters
- Industrial Inverters
- Vibrapacks
- Polarity Changers
- "A" Battery Eliminators
- Battery Chargers
- Rectifier Packs
- Special Supplies
- "A-B" Power Units
- Inverter Vibrators

NEW DESCRIPTIVE CATALOG NO. 139 NOW READY

Write today for Your Free Copy

ATR Auto and Farm Radio Vibrators—Fully Guaranteed for 1 year. Featured in the January issue of Radio Retailing. Write for your Free Copy of ATR Vibrator Guide and Equivalent Chart and details of Free offer.

AMERICAN TELEVISION & RADIO CO.

World's Largest Manufacturer of Vibrators and
Vibrator-Operated and Rectifier Power Supplies.

St. Paul, Minnesota, U.S.A. Cable Address: "Likex" N.Y.

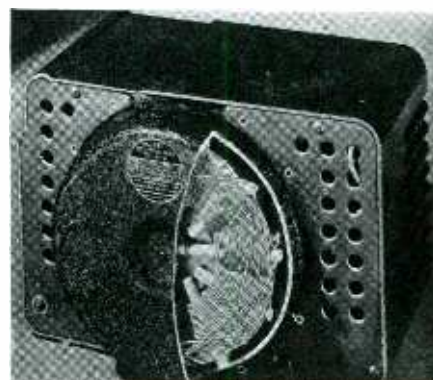

AEROSCOPE—No antenna or ground required on Admiral sets equipped with the Aeroscope, a large inductance built into the back of each set.

TRICKS

PHILCO MAGNETIC TUNING MODELS

Magnetic tuning or AFC will not balance correctly on both sides of channel—replace type 6N7 oscillator control tube.

PILOT DRAGON 10

Hum . . . look for ground at the reflector mounted behind the pilot light. Replace fiber insulation at this point.

RADIOLA 17

No reception . . . look for open section in voltage divider located on chassis sub-base of socket power unit. From where output of rectifier feeds into divider, value of sections in their order are 500, 4,000, 2,500, 200 and 1,900 ohms.

PHILCO 54

Weak . . . replace open 12 mfd. electrolytic filter condenser. Dead . . . check C 31 a .00011 mfd. unit from plate to cathode of 75.

PHILCO MODEL 57

No signal—bad resistor No. 21 . . . Unless the voltages on the 77 detector tube are correct this set will not work.

PHILCO 71

Distortion . . . replace 70,000 ohm plate resistor on first audio with 50,000 ohms.

PHILCO 620

Noisy . . . ground 6A7 control grid temporarily. If noise stops suspect primary of 78 r.f. coil.

PHILCO 650

Reluctant oscillator, oscillator won't start when set is first turned on . . . leaky condenser part No. 71A in screen circuit of 6A7.

PHILCO CONE-CENTRIC TUNING MODELS

Noise when dial is turned . . . clean and polish spring, also clean and polish facing on which this spring rides. Spring located under dial.

RADIOLA 64

Fading, intermittent reception, stations received below their original setting . . . connecting tabs on oscillator series trimmer condenser have snapped.

RCA 221

Hum, especially on stations . . . open 4 mfd condenser in pack. Connects from R6 (20,000 ohms) to ground.

RCA VICTOR 9K3

Insufficient bass . . . shunt a 25 mfd., 25 volt bypass across the 6L6 cathode resistor.

RCA 15K

Intermittent . . . broken or shorted voice coil. Replace with new cone.

RCA VICTOR T6-9, C6-2, T6-1

Hum with the volume control in the extreme minimum position . . . if filter condensers are good, reverse either the voice coil or the hum-bucking leads.

MR. SERVICEMAN

Make the Most of Your Time in '39!

MAIL THIS COUPON

RADIO SERVICEMEN OF AMERICA, INC.
304 South Dearborn Street, Chicago, Ill.

GENTLEMEN:

I hereby make application for membership in the Radio Servicemen of America.

NAME _____

MAILING ADDRESS _____

CITY _____ STATE _____

I am enclosing \$4.00 for Dues and Initiation. (Does not include Local Chapter Dues where Local Chapters are organized.)

Let's Grow Together in 1939

RADIO SERVICEMEN OF AMERICA, INC.

Joe Marty, Jr., Executive Secretary ★ 304 S. Dearborn St., Chicago

Make progress this year by using your time to the best advantage. Tie-up with the only national independent servicemen's organization in the industry and enjoy its benefits! The RSA is cooperative—run by and for its members—uncontrolled by any outside interests. You elect your representatives — all responsible officers are bonded.

Here's what RSA gives you:
★ Monthly Advanced Circuit Notes for Members each month. ★ Technical Help on Service Problems. ★ Access to its National Speakers Bureau. ★ Advanced Service Courses to Members at slight cost. ★ A Monthly RSA Publication. ★ Annual Convention. ★ And many other benefits now being planned.

Join up with your fellow serviceman and be "in." Send the Coupon Today!

National Yearly Dues . . \$3.00
Initiation Fee 1.00





RESISTANCE ANALYZER and INDICATOR

FOR USE WHEREVER RESISTANCE MEASUREMENTS ARE MADE

An indispensable radio instrument for every ham, serviceman and experimenter. Fuse protected, fool-proof, guaranteed. Dozens of uses. Determines resistance values; estimates tapers and values of controls; serves as voltmeter multiplier, rheostat or potentiometer; voltage divider; calibrated gain control or attenuator, etc., etc. Direct reading dial. Only 1 knob adjusts resistance from 0 to 1.0 megohm. Bakelite case 4 3/4" x 3 1/4". Three fuses. Interesting 16-page instruction manual supplied with each Analyzer.

Net Price (complete) . . . \$4.95



All Metal 11" long x 5 1/2" deep x 5 1/2" high

RADIO'S HANDIEST PARTS CABINET

This new All-Metal IRC RESIST-O-CABINET contains the first really balanced resistor assortment. Supplied complete with 59 famous IRC Resistors in practically every type and range commonly used in service work. You pay only the standard prices for the resistors. The cabinet is yours at not one cent of extra cost. The 59 resistors include popular ranges in 1/2- and 1-watt Insulated Metallized Resistors; also 10-watt fixed and adjustable wire wounds, the latter giving every range from a few ohms up to 10,000 ohms. Cabinet contains four large drawers with seven compartments in each. Designed to stack solidly, one atop the other.

List Value of Resistors \$15.16 (The Cabinet is included)

NOTE: Resist-O-Cabinet not sold empty.



By the makers of **INSULATED Metallized RESISTORS**

STANDARD OF QUALITY EVERYWHERE

IRRESISTIBLE SALES TALK

(Continued from page 61)

circumstances are such that we can safely do so . . . because whether or not we sell an electric refrigerator depends, in a vast majority of the cases, on one thing, and one thing entirely: getting in the house so that we can get our story across.

If we have had to be more or less dignified and formal with the lady, we'd better leave it unsaid—because she may get the impression that we're worried about making the sale, and we don't want her to think that for a minute. But if we've managed to get sort of chummy with Mrs. Jones, and we know she wants the box and that our only obstacle left is Mr. Jones, then we can make our departure thus:

"All right, want to do me a favor, Mrs. Jones?"

The lady will probably smile and say yes.

"Well, when I ring the bell tonight, at seven, will you come to the door—and let me in! That's all I ask. After I'm inside, I'll do the rest. You want the box, and I'm quite sure I can convince Mr. Jones that he should buy it for you—but I can do it much better in here. You know, Mrs. Jones, it's awfully hard to sell electric refrigerators on the front porch—especially after the sun goes down!"

SOUND LICENSES & PERMITS

(Continued from page 28)

censing many sound specialists who do a large volume of music reproduction work on a fee basis for a yearly license, and in some cases on a percentage fee.

Some Copyrights Expired

However, all musical compositions published are not under its jurisdiction. Many copyrights have expired and *Radio Retailing* published a large list in the March, 1938 issue, titled "Songs for Your Sound Truck."

Several states have passed "anti-ASCAP" laws outlawing the collection of music royalties within their borders. However on December 1, 1938 at Knoxville, Tennessee, the Federal Constitutional Court granted the ASCAP an in-



C-D Quietone RADIO INTERFERENCE FILTERS

Like all C-D products—Quietone Radio Interference Filters were tested under exaggerated "life" conditions before being introduced to the industry. That's why we can say with confidence . . . "THEY ACTUALLY WORK".

Don't overlook this opportunity to increase your sales with little or no effort. Extremely simple to install, unobtrusive in appearance and available in three colors to match room interiors, C-D Quietones were designed for minimum sales resistance. On your next call demonstrate Quietone—and see how easy it is to increase your profit on each and every call.

Remember—for new profits demonstrate C-D Quietones, the interference filters backed by the twenty-nine year C-D seal of quality. Attractively priced to retail from \$1.00 up. Cat. No. 166A on request.

Product of the world's largest manufacturer of capacitors.



EQUIPMENT for the SERVICE ENGINEER



Model VR-7 Signal Generator—net price f.o.b. \$45.00

- Unconditionally guaranteed for one year
- Unequaled performance

Specifications

Tuning mechanism—special 3,600 degree types; Output—1 microvolt to 1 volt; Modulation—400 cycles, variable 0-80%; Calibration—separate graphs; Output control—six step multiplier and vernier microvolter; General Radio and National German-Silver controls. Dials mounted against engraved burnished bronze panel in hand-rubbed straight grain walnut cabinet. Size 14 1/2" wide, 7 1/4" high, 8" deep. Operation is on 100 to 117 volts, 24 watts.

Model VD-3 Standard Radio Frequency Microvolter—net price \$85.00 f. o. b.

Model VG-6 Vacuum Tube Voltmeter—net price \$25.00 f. o. b.

Write for latest catalogue of fine Equipment for Service Engineers.

TELEVISO COMPANY
337-345 North Pulaski Road
Chicago, Illinois

junction restraining the officers of Tennessee from enforcing their anti-ASCAP bill.

Anti-ASCAP laws have been passed in Washington, Montana, Nebraska, Florida and Tennessee. At the present time the ASCAP is appealing an adverse decision in the State of Washington; Nebraska, Florida and Tennessee cases have resulted in decisions favorable to the ASCAP. As yet, no decision has been reached in Montana.

The Society of European Stage Authors and Composers (SESAC) located at 113 West 42nd Street, New York City, handles most copyright matters and licenses with regard to European copyrighted selections.

A new society formed by Shalom Secunda, composer of "Bei Mir Bist Du Schon," known as the Society of Jewish Composers, Publishers and Song Writers, is located at 1501 Broadway, New York City.

Artists Are Organized

Besides the general musical copyrights controlled largely by these companies, there are societies which control the license for some of the artists who perform in recording the selection. One of these companies is the National Association of Performing Artists, Inc., 580 Fifth Avenue, New York City.

Another artist society is the American Society of Recording Artists, Inc., 6513 Hollywood Blvd., Hollywood, California. Both of these organizations control the licensing for the majority of big name radio and stage stars, orchestras, vocalists, and other groups who now make records under the various labels.

However, all artists do not belong to these two societies of performing artists. Tommy Dorsey and his orchestra is one of the exceptions and no performing permit is necessary to reproduce records of his orchestra, outside of the ASCAP copyright permit.

Record Makers Tied Up

The major record companies instituted a policy in a large number of states several months ago forbidding the sale of records by their distributors to sound equipment dealers who use same for rental amplification at dances.

This cannot be held against them

(Continued on page 75)

More for your Money

with the New



Universal Supertester

"More for your money"

is a term often used by advertisers. But never has it hit closer to the mark than when we say "More for your money" with this new RCP instrument.

Just check what you get for \$16.25. You'll be quick to agree that the Model 411 is the most comprehensive tester ever produced at the price. Ideal for the *serviceman*—equivalent of 33 individual instruments. Just the job for *television*—ranges up to 5000 volts AC and DC; reads 4 microamps to 25 amps AC and DC. Best all around tester for the *ham*—low and high AC and DC voltage, resistance and current ranges. Unequaled for the *electrician and engineer*—makes possible maximum number of useful measurements for plants, labs, substations, etc.

Model 411 complete net— **\$16.25**
 Model 411B same as Model 411 with additional provision for testing ballast tubes with octal bases —net—\$17.95.
 Model 411P same as 411 except

in portable hinged cover case—
 —net— **\$17.75**

Model 411BP same as 411B except in portable hinged cover case —net— 19.45.

Some of the unusual features of this instrument are:

- 5 stage, high AC-DC voltage range to 5000 volts.
- High voltage not applied to selector switch nor to general test circuits.
- 3 stage, high AC-DC current range to 25 amps.
- Center of scale, on low ohmmeter range, only 5 ohms with each of first ten divisions measuring 0.1 ohm.
- 3 stage easy reading, high ohmmeter range up to 4,000,000 ohms.
- 3" square meter with movement of 200 microamperes or 5000 ohms per volt.
- DC microamps 0-200.
- db meter from -10 to 69 db in 4 stages
- DC milliamps 0-500.
- Output meter same as AC volts.



SH! CONFIDENTIAL! Advance Engineering Bulletin!
YESSIR! RCP engineers sure have been working overtime. We just heard that the new Model 504 analyst will be ready within the week.

Here's a multiple circuit selector that gives maximum speed and flexibility for analyzing symptoms at terminals in radio sets and P.A. systems. Here are a few of the special features of this new job:

- Octal tube socket built into unit.
- Pushbutton switches for both current and voltage. New RCP circuit developments prevents "shorts" when two or more buttons are pushed at same time. This protection not available in any other instrument.
- Current and voltage can be checked at same time.
- Latest toggle latch plug and 7 adapters.

Model 504 complete with all adapters **\$13.75**
 Model 504C same as 504 with 3" deep case **14.95**

You can't beat RCP for "real" values. See the complete RCP line at your local distributor or write direct for catalog.

RADIO CITY Products Co. INC.
 88 PARK PLACE NEW YORK CITY



Old Man Centralab took his baptism in a furnace at 2500 F.

He laughs at such temperatures as 200 degrees . . . the sort of heat he has to take sometimes when he is parked near a ballast resistor or a transformer in a radio receiver.

Even where chassis temperatures ARE elevated the Centralab resistor, with its complete ceramic construction baked at 2500 degrees, laughs at a mere 200 degrees. Where ordinary fixed resistors break down under temperatures of 200 or even less, Centralab is positively unaffected.

Join the thousands of Centralab addicts . . . specify Centralab for original equipment or replacements.

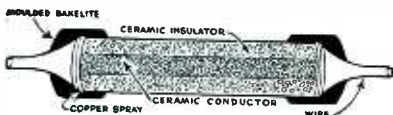

Baptized in fire at 2500 degrees . . . hard as stone. Center ceramic core, and ceramic jacket fired together to form a single shock-proof unit. Pure copper covers resistor end for wire lead contact.

CENTRALAB: Div. of Globe Union, Inc.
Milwaukee, Wisconsin

Centralab
FIXED
RESISTOR

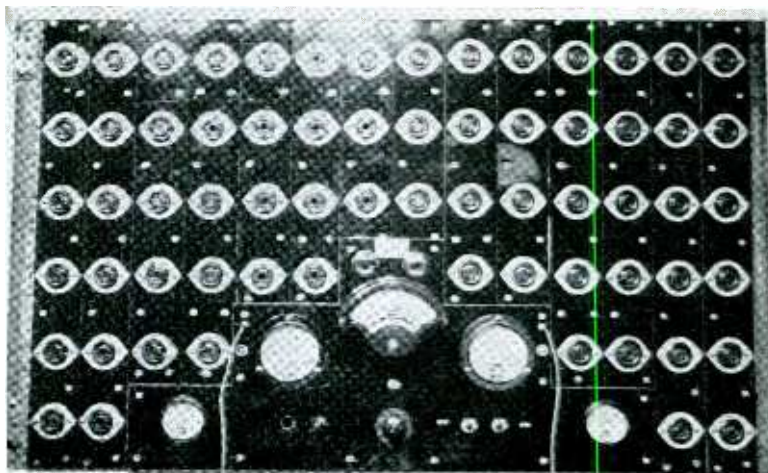

LET 'EM COME—Futuristic tube tester designed by M. G. Goldberg, St. Paul, to accommodate ever increasing tube types. Has 66 sockets mounted in strips so that changes can be easily made. Provides necessary test for any receiving tubes; ample space for new arrivals.

Line Voltage Regulator

By H. D. Hooton

In many communities, particularly those near industrial centers, considerable trouble is often experienced from fluctuations in line voltage. This is especially serious for the radio serviceman as it sometimes makes accurate checking of receiver circuits difficult due to the fact that the voltage readings obtained will not correspond to the values given in the manufacturer's data sheets. Usually these fluctuations are caused by a variation of the load on the line and may be taken care of by the use of a manually-operated compensating device.

A simple arrangement is shown in Fig. 1. A small bell-ringing or toy-train transformer is used to "boost" or

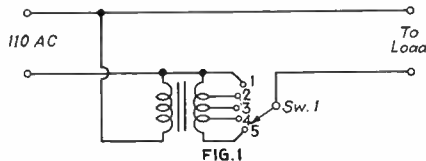

"buck" the line voltage according to the connection of the windings. The secondary must be tapped, varying between 6 and 20 volts in steps of 2 or 3 volts and the wire must be of a size sufficient to carry the full load current of any receiver to be tested without undue heating. As Fig. 1 shows, the secondary is connected in series with the line voltage and, if the polarity of the windings is correct, the voltage applied to the receiver can be brought up to the rated 110 or 115 volts by merely placing the switch contact on the proper tap. If the polarity of the two windings happens to be reversed, the currents will "buck" each other and the voltage will be reduced. This method may be used in communities where the line voltage is consistently higher than 110 volts and is to be

preferred to the use of resistor in the primary of the transformer as the voltage regulation is not affected.

Repair of Band Changing Switches

By James A. Nash

Noise and fading in multi-band receivers is often caused by loose or uncertain connections between the rotor and stator points of the band-changing switch. After considerable use, the rotor wipers lose their spring action and fail to press with sufficient tension against the stator faces.

To adjust wipers for firm connections, proceed as follows: remove thin, metal collar (it looks like an open-end lock washer), wedged between threaded neck and shaft. This is accomplished by inserting the point of a small nail or other instrument into the space between the open ends of the collar so as to spread the collar open sufficiently for complete removal by a larger tool, such as a screw driver or a pair of pliers which are unsuitable to start the process. Do not pry collar open too wide as it may break.

Removing the collar permits the shaft and its component fiber piece with the rotor wipers to be pushed out the back of the stator part of the switch. (As this is being done, a few leads on the rotor piece may become taut, making necessary their removal; it will perhaps not be necessary, however, to remove many.) In this manner, access is gained to the rotor wipers. Proceed then to bend each wiper up about one-eighth inch more from fiber piece, endeavoring to make all the same distance from it. This gives new spring action to the contacts.

JIM QUAM Says



About the quickest way to ruin a good business reputation is to start chiseling on quality. Shaving a few pennies from costs by using a slightly lower quality material, a few turns less of copper or an ounce or two less of steel—all these things can be done and each one in itself is hardly perceptible in the performance of a finished speaker. But taken all together, there is a decided difference in performance and in the way a speaker stands up.

Maybe we could build a cheaper Quam Speaker, the same way, and sacrifice performance for price, but we're not going to build anything the way our ground of, and judging the way radio business has been going, reliable about manufacturers feel the same way about it. Of course, when we can cut costs, not by chiseling materials or cutting wages, but by better manufacturing technique, that's progress and we like to pass the savings along. We've found long ago that quality really pays.

QUAM-NICHOLS CO.
33rd Place & Cottage Grove CHICAGO 1674 Broadway NEW YORK



The AMPERITE ACOUSTIC COMPENSATOR

gives you
HIGH OR LOW PITCH
WITH THE SAME MICROPHONE

With the flip of a finger you can now (1) lower or raise the response of the microphone. . . (2) adjust the microphone for most desirable response for close talking or distant pickup. . . (3) adjust the system to any "taste", room condition, or equipment.

MODELS RBHk, RBMk, with Acoustic Compensator, frequency range 40 to 11000 cps, output, -65 db., complete with switch, cable connector and 25' of cable. . . \$42.00 LIST

NEW! MODEL RSHk (hi-imp); RBSk (200 ohms) Frequency range 60 to 8000 C.P.S. Output -68db. . . Chrome or Gun-metal . . . \$32.00 LIST

NEW LOW PRICE CONTACT "MIKE"
Model SKH (hi-imp); SKL (200 ohms) \$12.00 LIST

MODELS RAH-RAI, excellent for speech and music. Reduce feedback. . . \$22.00 LIST

Write for Complete Illustrated Bulletins and Valuable Sales Helps.

AMPERITE CO. 561 BROADWAY, N. Y.
O. Cable Address: Alkem, New York

AMPERITE Velocity MICROPHONE

SOUND LICENSES & PERMITS

(Continued from page 73)

for an agreement made by the major record companies with the American Federation of Musicians with respect to the union orchestras used in recording nearly every selection forbade their use by anyone for commercial purposes, to wit, radio stations, sound dealers, sound specialists in music rentals.

On every record that appears today, the following statement or a similar one appears:

"This record is licensed by the manufacturer for non-commercial use on phonographs in homes. The original purchaser has expressly agreed with the manufacturer of this record that it will not be resold or used for any other than for non-commercial use on phonographs in homes. All subsequent purchasers are notified that this record may be used only for non-commercial purposes on phonographs in homes."

However, sound-men when refused the sale of records by the various distributors have frequently bought same from retail stores.

Still In State of Flux

Several states in the ASCAP cases have held that when a phonograph record or electrical transcription is used at a football game, baseball game, etc., where the general admission charged is not for the music but for the other event, that an ASCAP copyright is not being violated.

However, when a record is used for straight musical amplification supplanting a live orchestra, the record is used for a commercial purpose. Sound-men have generally experienced little difficulty from the American Federation of Musicians in their music work. With the many A. F. L. Electrical Unions signing agreements with the various sound men, little trouble is to be expected in the future.

In the majority of cases, sound specialists have never replaced a live A. F. L. orchestra with their music amplification. In practically every case it has been a small four or five-piece non-union orchestra in which the American Federation of Musicians is not interested.

Anti-Noise Laws

Several cities have instituted anti-noise laws and measures which were destined to remove all loud speaker trucks from the streets and outdoors. However, most of these laws in the various cities have a time

(Continued on page 76)

THIS Little DEVICE HAS CHANGED THE Radio Tester World

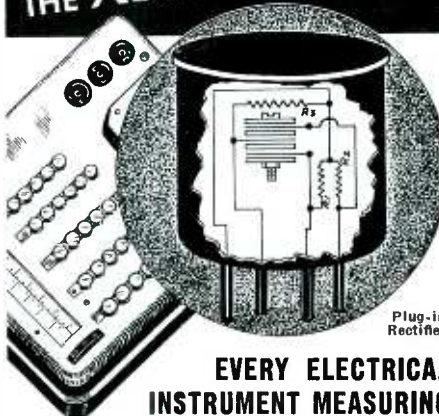

EVERY ELECTRICAL INSTRUMENT MEASURING A. C. VOLTAGES AT HIGH RESISTANCE SHOULD HAVE IT

• Previous Problem:

Deactivation of copper oxide rectifiers caused by overloads, caustic gasses or humid atmospheric conditions prevalent in every locality at some period of time has heretofore necessitated the complete recalibration of the tester circuit in which the rectifier was incorporated on insertion of a new copper oxide rectifier. In most cases this meant return of the complete tester to the factory, with its attendant delay and expense.

• Triplett's Answer:

A plug-in unit incorporating a new copper oxide element precalibrated to a factory standard and thus when plugged into the tester gives you factory calibration. As simple as plugging in a tube. Obtainable through jobber or direct. Rectifier elements are the best obtainable—completely sealed for maximum protection against humidity and caustic gasses. The great practicability of this little device has in truth changed the Radio Tester World.

THESE and OTHER TRIPLET MODELS have Plug-In RECTIFIERS



MODEL 1601 DELUXE SET TESTER

Complete in Leatherette Case . . . DEALER NET PRICE \$49.33. In Metal Case. DEALER NET PRICE \$45.33.

MODEL 1611 PUSH-BUTTON TUBE TESTER AND VOLT-OHM-MILLIAMMETER

Complete in metal case. DEALER NET PRICE \$49.50.

SEE YOUR JOBBER—WRITE FOR CATALOG!

THE TRIPLET ELECTRICAL INSTRUMENT CO.
202 HARMON AVE., BLUFFTON, OHIO



Either Way... it's AEROVOX



● Since imitation is the sincerest form of flattery, our competitors are showering us with genuine compliments. One by one, they are introducing exact-duplicate replacements. Which means that, at long last, they now concede what we have claimed for years, namely:

EXACT DUPLICATES

● are essential in pleasing fussy set owners. Save time, trouble, money. Likewise your future as a GOOD serviceman. And AEROVOX, pioneer in this field, has built up the most extensive line available. A unit for every type of set. FITS right, LOOKS right, WORKS right. Restores set to original NEW condition.

GENERAL UTILITY

● units are recommended only for emergency or hurry-jobs where set owner is more in a hurry than he is fussy. AEROVOX line includes ALL necessary types of general-utility condensers, such as compact cardboard case and midget metal-can electrolytics, standard long and short metal-can electrolytics, paper tubulars, etc.

Ask for DATA...

● Your jobber can give you a copy of our latest catalog containing listings of exact-duplicate units. Ask to see the wall chart. Or write us direct.



SOUND LICENSES & PERMITS

(Continued from page 75)

clause after a certain hour (11 p.m. in many cases) and within 150 feet from the sound source.

Sound-men have usually installed several speakers at various points to overcome this law's measures. This usually conforms, in that the number of speakers are operated each at a low level, whereas, if two or three speakers were used, each would have to be operated at a large output to overcome the large area or crowd noise.

THREE STRIKES ON SERVICEMEN

(Continued from page 63)

"Well, give me a dollar and I'll call it square."

"I'll do better than that," says the housewife, "I'll give you 50¢ and we'll call it square." So the serviceman takes a licking because he handled the whole thing in a punk manner. I think that if the serviceman isn't set to put in 30 minutes in a house, he hasn't any business making the call. There are plenty of boys who never get a peep out of the customer when they lay down on the table their \$1.50 bill, and here is how they do it:

1. They take ten minutes to check all the tubes.

2. They ask the Mrs. for a dust rag and brush off the dust from the cabinet and chassis.

3. They dash about the house, check the aerial and see that the ground connection is tight.

4. They check the dials for the proper setting, and see that the dial light is going (in nine cases out of ten it is burned out).

5. They call in the Madam and instruct her how to tune the radio.

The set may have needed no more than a new 80 tube, just as the five-minute guy found, but after this going-over no housewife is going to have the crust to try to chisel on that \$1.50 call. She has got her money's worth. Hasn't she seen the serviceman in action, as busy as a beaver, all over the house and hitting on all six? I'll say she has.

These are the things that get three strikes on the serviceman. These are the things that get his goat, and give him that inferiority complex. And the foolishness of it all is, these are all things that can be licked. Next time something like this pops up, try these recipes on your piano.

In tune with
1939



● Better and more profitable servicing—that's the CLAROSTAT keynote. More comprehensive servicing data . . . exact-duplicate replacements where needed . . . quality components that can be installed and forgotten—that's the CLAROSTAT line for 1939!

CONTROLS

● CLAROSTAT Midget Controls have met all tests, trials, tribulations, with flying colors. Designed from scratch, brand new in every way, these compact, rugged, quality controls have gained outstanding popularity. Just try one. You'll be surprised!

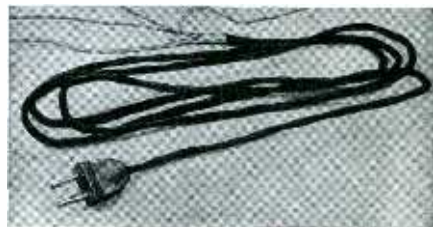

POWER CORDS

● Typical of CLAROSTAT versatility in better servicing. Here's a line of voltage-dropping power cords. Seven types meet all standard AC-DC set needs.

PLUG-IN RESISTORS

● First to be introduced. Remain first in performance standards. Largest line of exact duplicates. Also universal types. Handy Plug-In-Resistor Tester is indispensable. Only \$7.45 dealer's net cost.



Ask local jobber about the CLAROSTAT line. Ask for latest servicing data. See our comprehensive wall charts for selecting proper replacement types. Or write us direct.



INDEX TO ADVERTISERS, February 1939

	Page
Aerovox Corp.	76
American Television Radio Corp.	70
Amperite Co.	55, 75
Bell Sound Systems, Inc.	51
Bitter Const. Co., A.	53
Brach & Co., L. S.	53
Centralab	74
Clarostat Mfg. Co.	76
Cornell-Dubilier Elec. Corp.	72
Crosley Corporation	78, Inside Back Cover
Crowe Nameplate & Mfg. Co.	53
Continental Radio & Television Corp.	32, 33, 34
Emerson Radio & Phonograph Corp.	4, 5
General Electric Co.	Back Cover
General Industries Corp.	51
Hygrade-Sylvania Corp.	29
International Resistance Corp.	72
Janette Manufacturing Co.	51
Kelvinator, Div. of Nash-Kelvinator	8, 9
Ken-Rad Corp.	51
Leonard	36, 37
Mallory & Co., Inc., P. R.	Inside Front Cover
Meissner Mfg. Co.	7
National Union Radio Corp.	59

	Page
Onan & Sons, D. W.	55
Operadio Mfg. Co.	45
Philco Radio & Television Corp.	10, 22, 23
Pioneer Gen-E-Motor Corp.	60
Quam-Nichols Co.	75
Radiart Corp.	56
Radio City Products, Inc.	73
Radio Corporation of America	26
Raytheon Production Corp.	3
RCA Manufacturing Co.	40, 41, 42, 43
Readrite Meter Works	56
Recoton Corp.	60
Regal Amplifier Corp.	54
Sentinel Radio Corp.	57
Service Instruments, Inc.	65
Simpson Electric Co.	69
Solar Manufacturing Co.	63
Star Machine Mfgs., Inc.	57
Stewart-Warner Corp.	6
Supreme Instruments Co.	61
Televisto Corp.	72
Triplett Electrical Instrument Co.	75
Tung-Sol Radio Tubes, Inc.	44
Utah Radio Products Co.	12
Universal Camera Corp.	55
Ward Products Co.	54

	Page
Webster-Chicago	67
Weston Electrical Instrument Corp.	2

SEARCHLIGHT SECTION Classified Advertising

Classification	Page
BOOKS	77
CATALOGS	77
EMPLOYMENT	77
INSTRUCTION	77
WANTED TO PURCHASE	77
RADIO STOCKS	
Burststein-Applebee Co.	77
Midwest Appliance Parts Co.	71
Mostow Company	77
New York Radio Supply Co.	77

Although Radio Retailing takes every precaution to insure accuracy, we cannot assume responsibility for an occasional change or omission in the above index.

McGRAW-HILL PUBLISHING COMPANY, INC. Publication Office: 99-129 North Broadway, Albany, N. Y. Editorial and Executive Offices: 330 West 42d Street, New York, N. Y.

SEARCHLIGHT SECTION

OPPORTUNITIES OFFERED

SALESMEN wanted to carry a side line of Wilton Rugs and Carpets. Commission basis. Territories open, Southeastern, South and Mid-West, SW-124, Radio Retailing, 330 W. 42nd St., New York, N. Y.

REPRESENTATIVES WANTED

With following of jobbers, factories, etc., to handle line of precision built test equipment at attractive prices. Features GLT, National, Hammarlund, controls and components. Excellent commission and bonus set-up. Opportunity to get in on the ground floor of a company that has advanced on the merit of its fair price plus quality policy.

RW-125, Radio Retailing
520 No. Michigan Ave., Chicago, Ill.

High Value! Low Prices!

ALL GUARANTEED FOR THREE MONTHS SEALED CARTONS

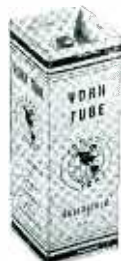

1C7G	\$.45	4230
1H4G	..35	5520
IV	..30	6A835
6A7	..35	6C535
6F7	..40	6F5G35
25Z5	..35	6K7G35
41	..30	6Q7G35
		25L6G45

We have a complete line of
Tubes. Write for Prices

**NEW YORK
RADIO SUPPLY CO.**
152 W. 42 ST. R.R. N. Y. C.

Wanted RECORDING EQUIPMENT

Professional type, cutting wax, recorder, shaver, etc. Describe fully.

Write P. O. Box 1, Lancaster, Pa.

WRITE FOR OUR NEW 116 PAGE CATALOG

of WASHING MACHINE AND VACUUM CLEANER PARTS

The Only Complete Catalog of Its Kind in the Country, That Can Be Used Profitably as a Service and Counter Guide With Retail Prices.

Dealers net prices on back pages

Established 10 Years. Reputation for Quality and Service.

MIDWEST APPLIANCE PARTS CO.
2722 W. Division St. Chicago, Ill.

MOSTOW PAYS THE SHIPPING CHARGES

All Orders of \$50.00 or More
Shipped Free of Charge.

All Orders From \$25.00 to \$50.00
Mostow Pays One-Half Shipping Charges.

SEND FOR OUR NEW CATALOG OF SENSATIONAL VALUES

THE MOSTOW CO.

Distributors of
Cameras—Photo Supplies
Projectors

100% Wholesale American Made
MERCHANDISE MART, CHICAGO, ILL.



EVERYTHING IN RADIO!

Our immense stock of radio sets, parts and supplies enables you to purchase your entire needs on one order. You will find all your Neatly Known Favorites in this big book which is FREE for the asking. Practically every order is shipped the same day it is received. Write for Catalog

BURSTEIN-APPLEBEE CO.
1012 16th Street S.E. Kansas City, Mo.

SERVICEMEN BOOST Your SERVICE PROFITS



Radio is rapidly becoming more technical. Competition demands that you know your "stuff". You must have a better-than-average technical knowledge to do more jobs quicker and with greater efficiency.

That's why **SPRAYBERRY ADVANCED "MASTER SERVICE TRAINING"** was developed. It was the first training (established 1932) of its kind for men already in the Service business, and it is still by far the finest, most practical and most complete. Includes over 50 new lessons, clear and simply written, on almost every essential Radio repair subject, including latest TELEVISION instruction. It's a compact, "all-meat" type of Training in Set Testing, Repairing, Parts Testing, Trouble Shooting, etc.

Do Better Jobs . . . Quicker

It is not a beginner's course. It is written for men already in the Service business. It shows you the easiest ways of doing the hardest jobs. Shows you time-saving short-cuts besides training you in actual business-getting methods. Many Servicemen have easily paid for this splendid Course out of increased earnings. Sold on terms as low as \$2.00 down—\$3.00 per month with iron-clad MONEY-BACK Agreement.

Don't fall into the rut of being satisfied with your present earnings. Self-improvement is the surest way to greater usefulness and bigger pay. Let me send you complete information at once. For your own sake, don't put it off.

RUSH Coupon for FREE Facts

SPRAYBERRY ACADEMY OF RADIO
1300-B University Place, N.W.,
Washington, D. C.

Please send, without obligation, complete details of your **MASTER SERVICE COURSE**.

Name

Address

City

State

(Paste on penny postcard or mail in envelope.)

CROSLLEY is

6 Reasons for profit

- 1 Shelvadors provide larger sizes in all competitive price levels.
- 2 Shelvadors provide lower prices for equal competitive sizes.
- 3 Shelvadors provide 12 price steps of from \$10 to \$20 a step.
- 4 Shelvadors match or better *all* 1939 electrical refrigerator refinements, improvements, features and design advances.
- 5 Shelvadors match or better *all* material specifications and craftsmanship in fabrication.
- 6 Shelvadors match or better *all* operating costs, load ratios and freezing performances.

PLUS that uncontroversial, unmatched, exclusive, top appeal to all women—the SHELVADOR!

"SPECIAL" LINE OF 4 QUALITY MODELS ON PRICE BASIS ONLY POSSIBLE IN NEW MILLION DOLLAR EFFICIENCY PLANT

6 cubic foot Shelvador \$132.50*
 Built to an acknowledged high standard of construction and performance. Hermetically sealed "Electro-Saver" unit—welded, bonderized all steel cabinet finished in durable DuPont Dulux.

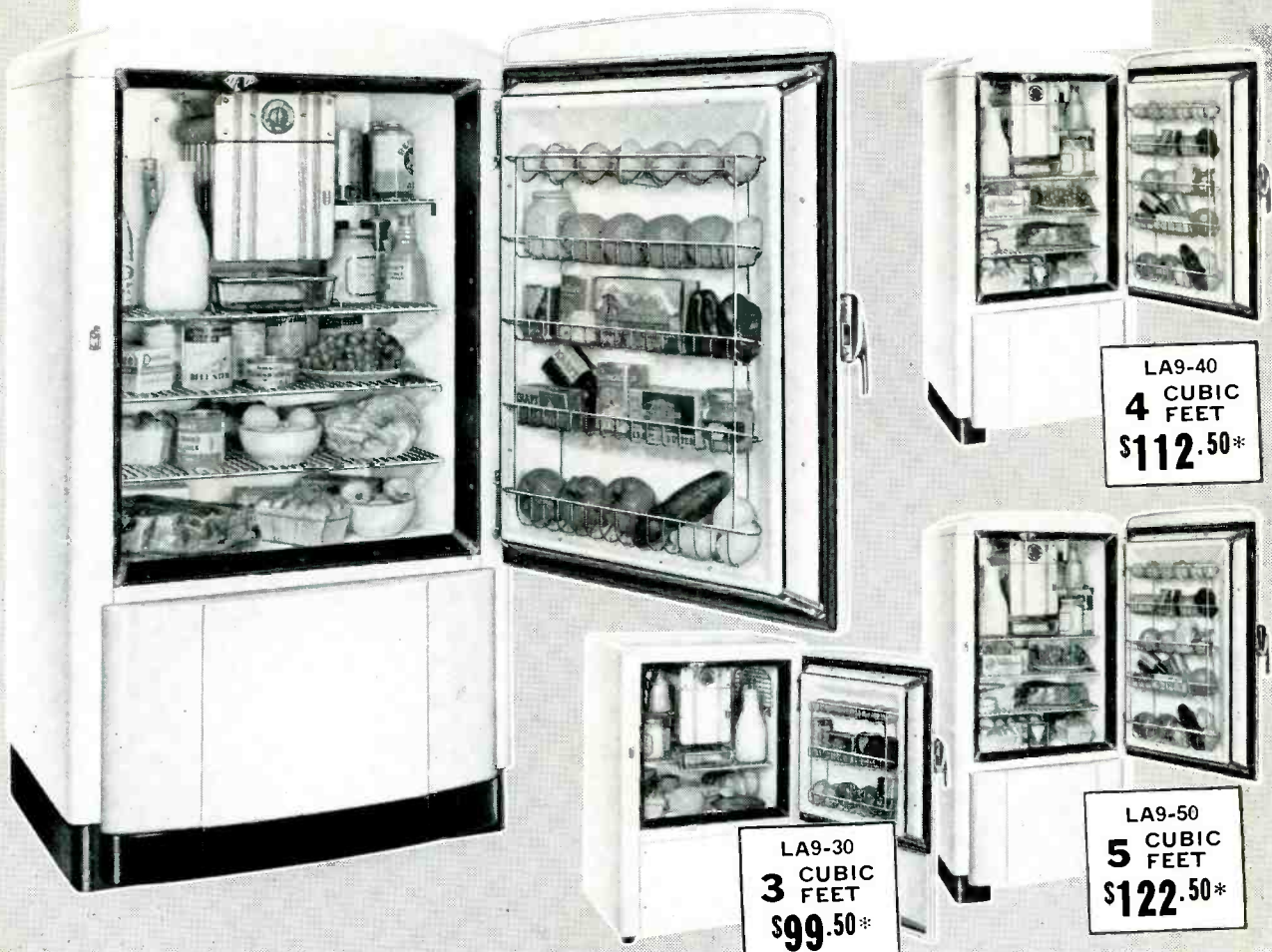

the line for '39

... 12 ways to make it

"REGULAR" LINE

4

COMPLETE REFRIGERATORS
MATCHING IN PRICE
THE "STRIPPED" LINES
OF COMPETITION



LB5-45
4½ CUBIC FEET
\$127.50*

LB5-55
5½ CUBIC FEET
\$147.50*

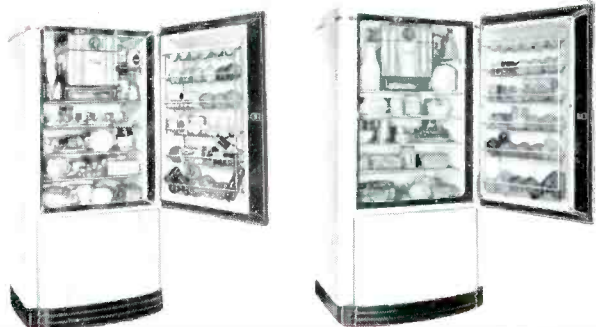

LB5-65
6½ CUBIC FEET
\$167.50*

LB5-80
8 CUBIC FEET
\$194.50*

"DELUXE" LINE

EQUIPPED WITH
LUXURY FEATURES THROUGHOUT
INCLUDING OVEN-PROOF POTTERY AT
WORLD'S
LOWEST
PRICES



LL5-45
4½ CUBIC FEET

LL5-55
5½ CUBIC FEET



LL5-65
6½ CUBIC FEET

LL5-80
8 CUBIC FEET

*DELIVERED AND INSTALLED . . . 5-YEAR PROTECTION PLAN \$5.00 ADDITIONAL . . . PRICES SLIGHTLY HIGHER IN SOUTH AND WEST
THE CROSLEY CORPORATION POWEL CROSLEY, Jr., Pres. **CINCINNATI**

HOT! HOTTER! HOTTEST!

NEW SERIES  **RADIOS**

ARE THIS YEAR'S VALUE SENSATIONS!

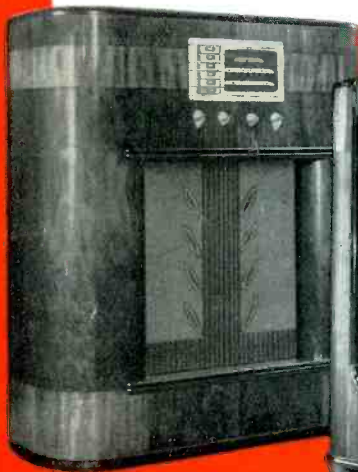

G-655



G-78



G-86

NEW
BEAM-A-SCOPE RADIO
at the lowest price ever

The exclusive G-E built-in Beam-a-scope — the feature of 1938 — is now offered in the new model G-86 at a sensational new low price.



NEW G-E WIRELESS RECORD PLAYER

No Wires — No Connections to Radio

Reproduces recorded music through the loudspeaker of any radio — electrically. Operates from any location — within hearing distance of radio set. No wires — no connections to radio. Turns any radio into a modern-type radio-phonograph combination. Priced to sell in big volume.



● Just Out! The newest and smartest line of radios G-E has ever presented. In features, in design, and in performance they set the pace. And they're priced at new and sensational lows. G-E sales soared to a new all-time high in 1938. And these great new, value-for-your-money models are headed for another record-smashing year. When you study the values offered in this new line you'll realize that G-E Radio means business in 1939. Phone your G-E Radio Distributor without delay.



G-64



GD-600



GD-610

GD-63

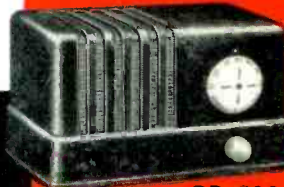

GD-500

Model GD-500 priced with the lowest — styled with the smartest. Mottled brown plastic cabinet. Also available in ivory finish with dials and controls in six lovely color combinations.

GENERAL  **ELECTRIC**